



IMMI 2018 – Modelling electroacoustic systems:
consideration of directivities exported from EASE





The aim of this tutorial is to demonstrate how to consider the directivity of line arrays when modelling the noise propagation within the framework of music events like concerts or festivals.



This is achieved by using .xhn-files from EASE.

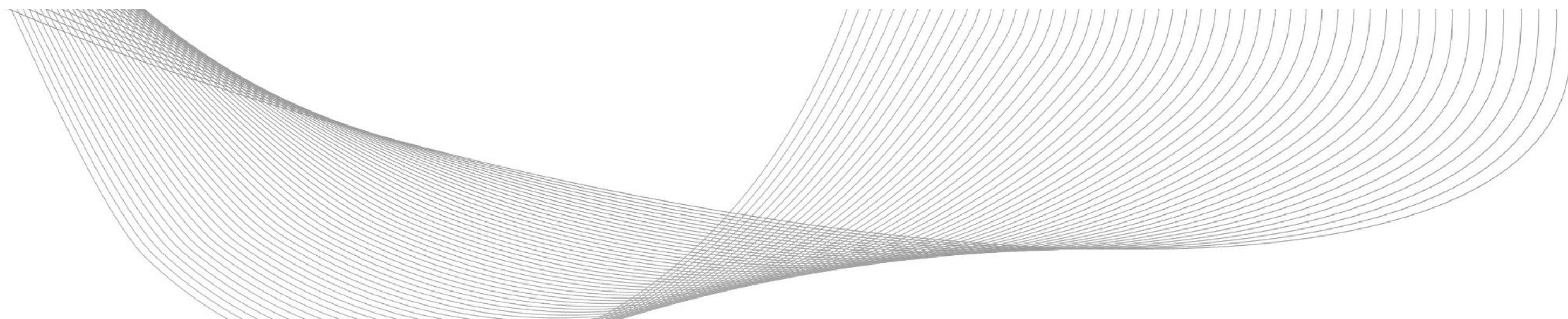

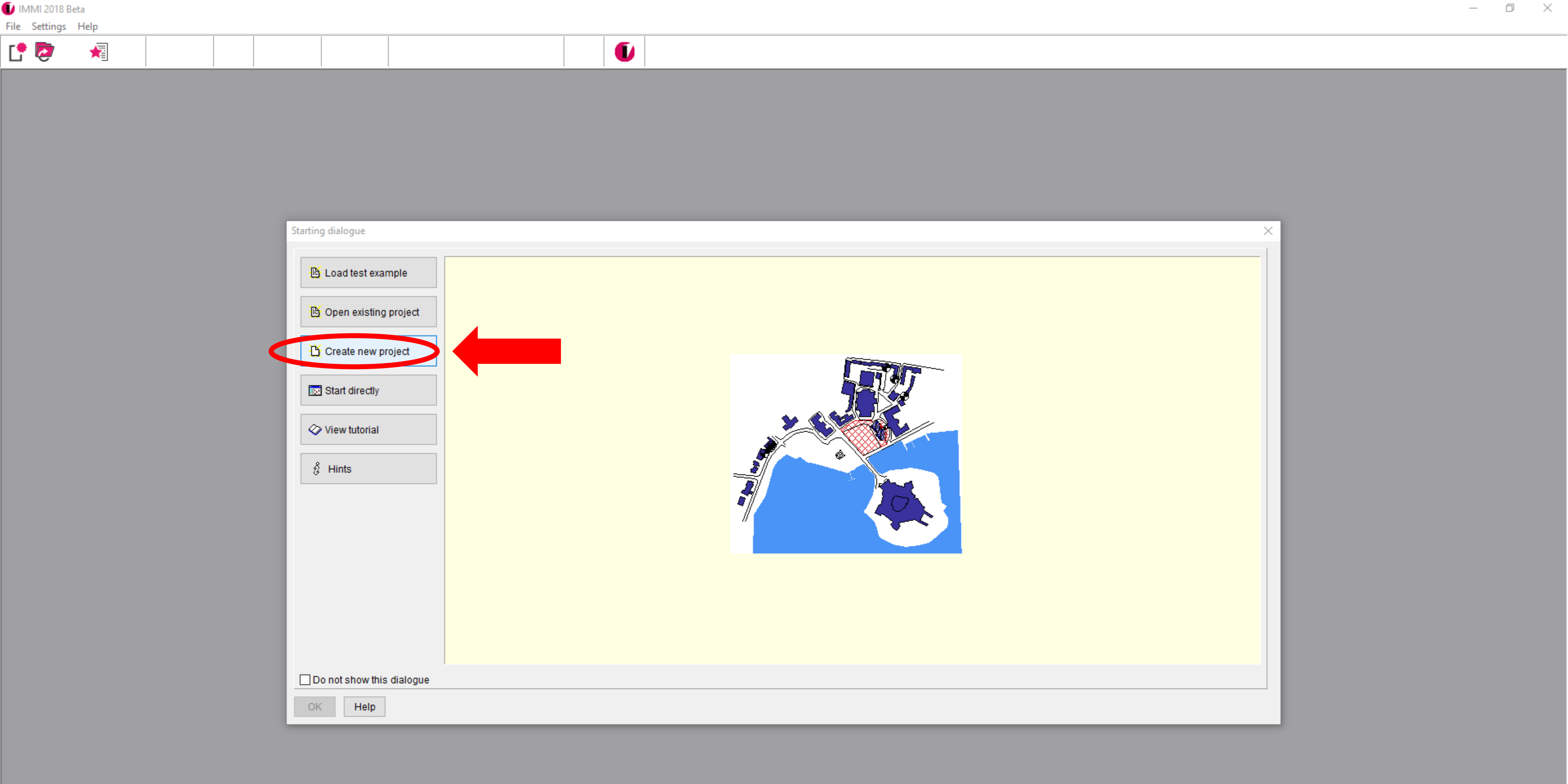

Start IMMI, choose "create new project" and confirm with OK.

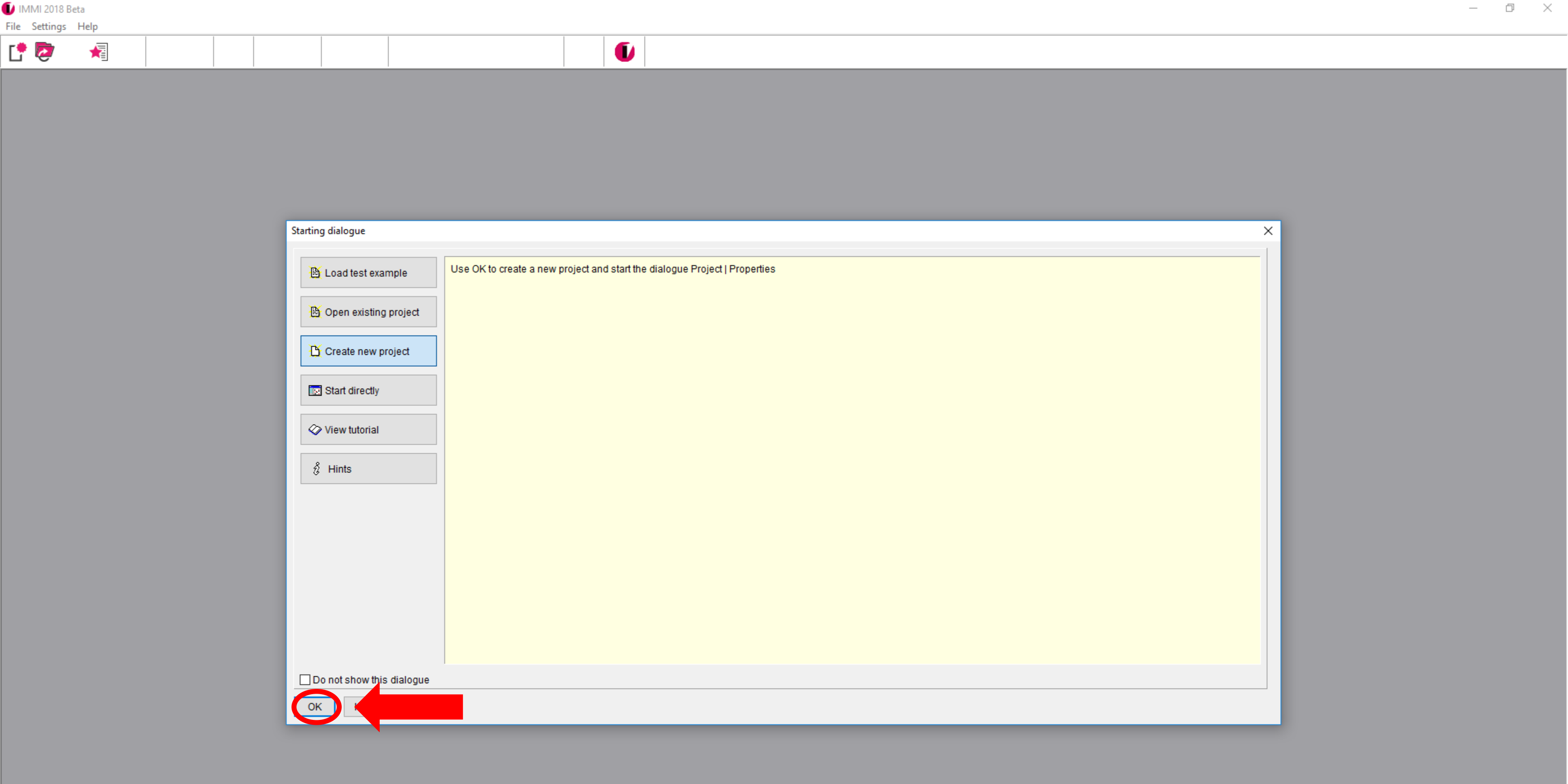

Start IMMI, choose "create new project" and confirm with OK.



Set project properties ...

Specification Work area Text field Headers

Set specification

Project template

Topic

Noise (Outdoor propagation)
 Noise (in working rooms)
 Aircraft noise
 Pollutants

Type of prediction
Noise (national methods)

Select rating method
No rating

Emission variants

	Duration/h
2 Day	16
Night	8

Select element libraries

Project description

Safety
Password: Not provided.

OK Cancel Help

In the dialogue for the project properties leave the default setting „Noise (Outdoor propagation)“ and reduce the emission variants to 1.



Set project properties ...

Specification Work area

Set specification

Project template

Topic

Noise (Outdoor propagation)
 Noise (in working rooms)
 Aircraft noise
 Pollutants

Type of prediction
Noise (national methods)

Select rating method
No rating

Emission variant Duration/h
1 Day 16

Select element libraries

Project description

Safety
Password: Not provided.

OK

Confirm with OK.

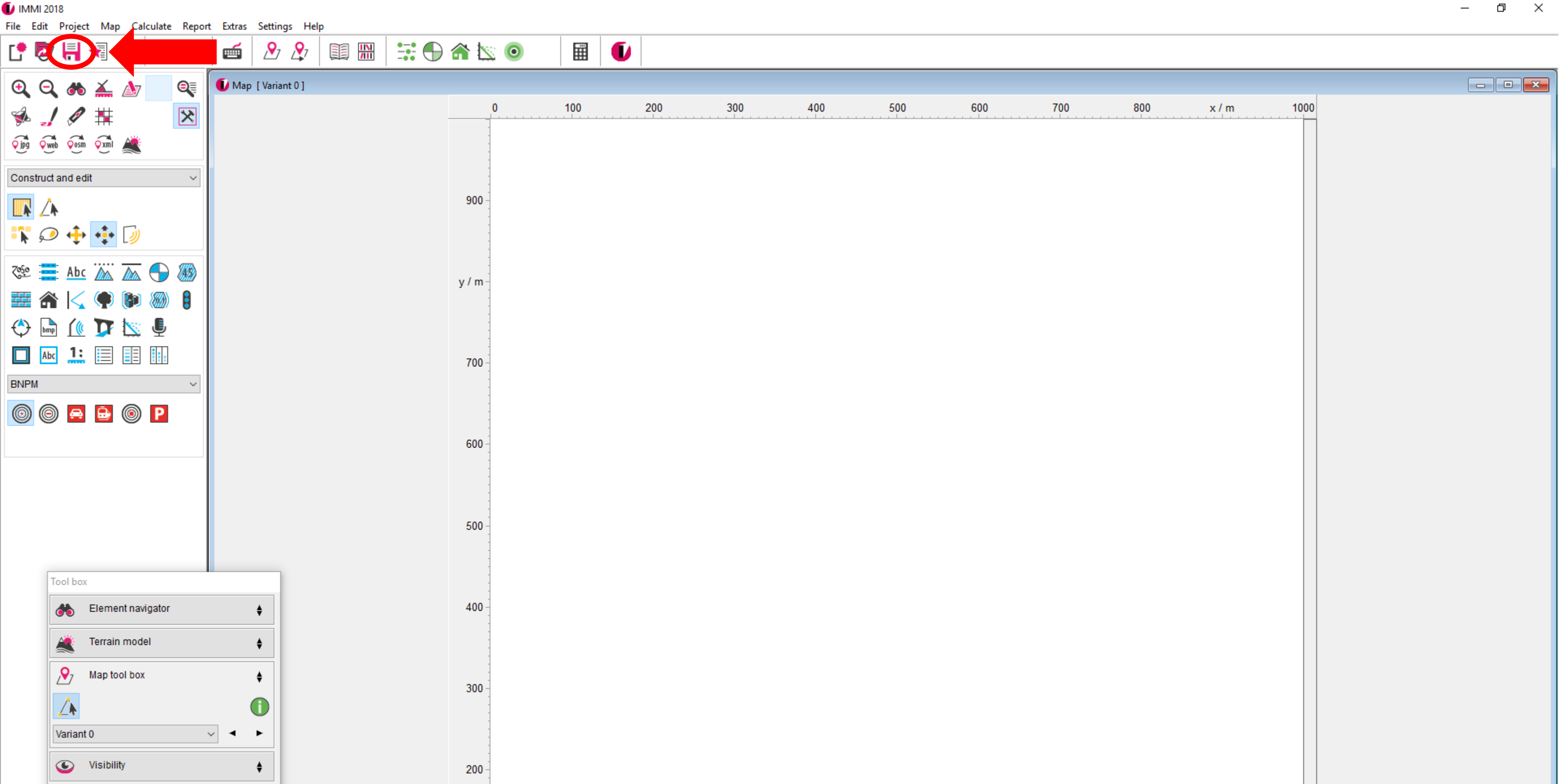

First, it is important to save the project. Please got to the respective icon.

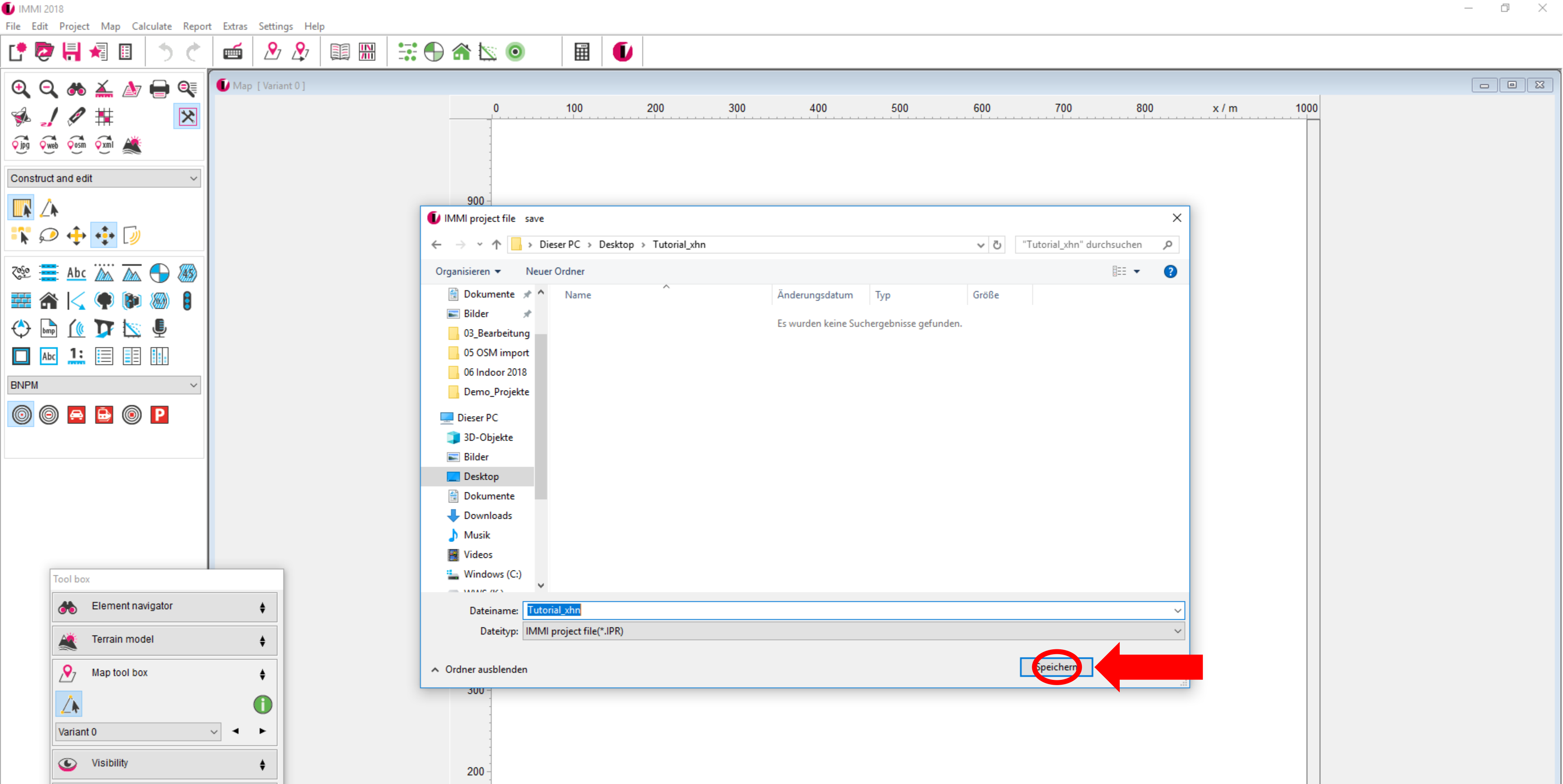

Select the path, create a project name and press „Save“.

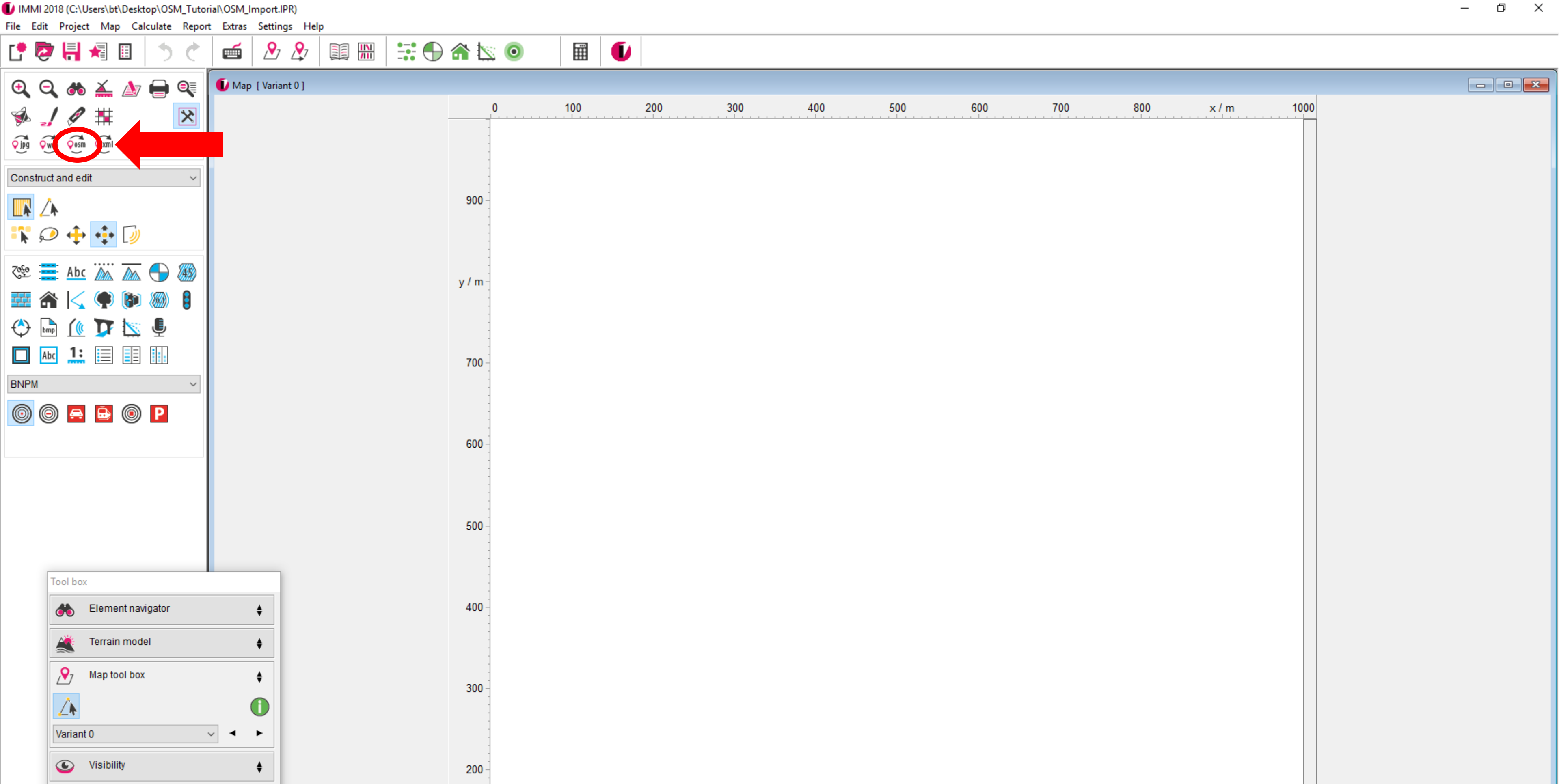

We will use the OSM import to create the background image and the houses in our area of interest. Please click the icon for the OSM import.

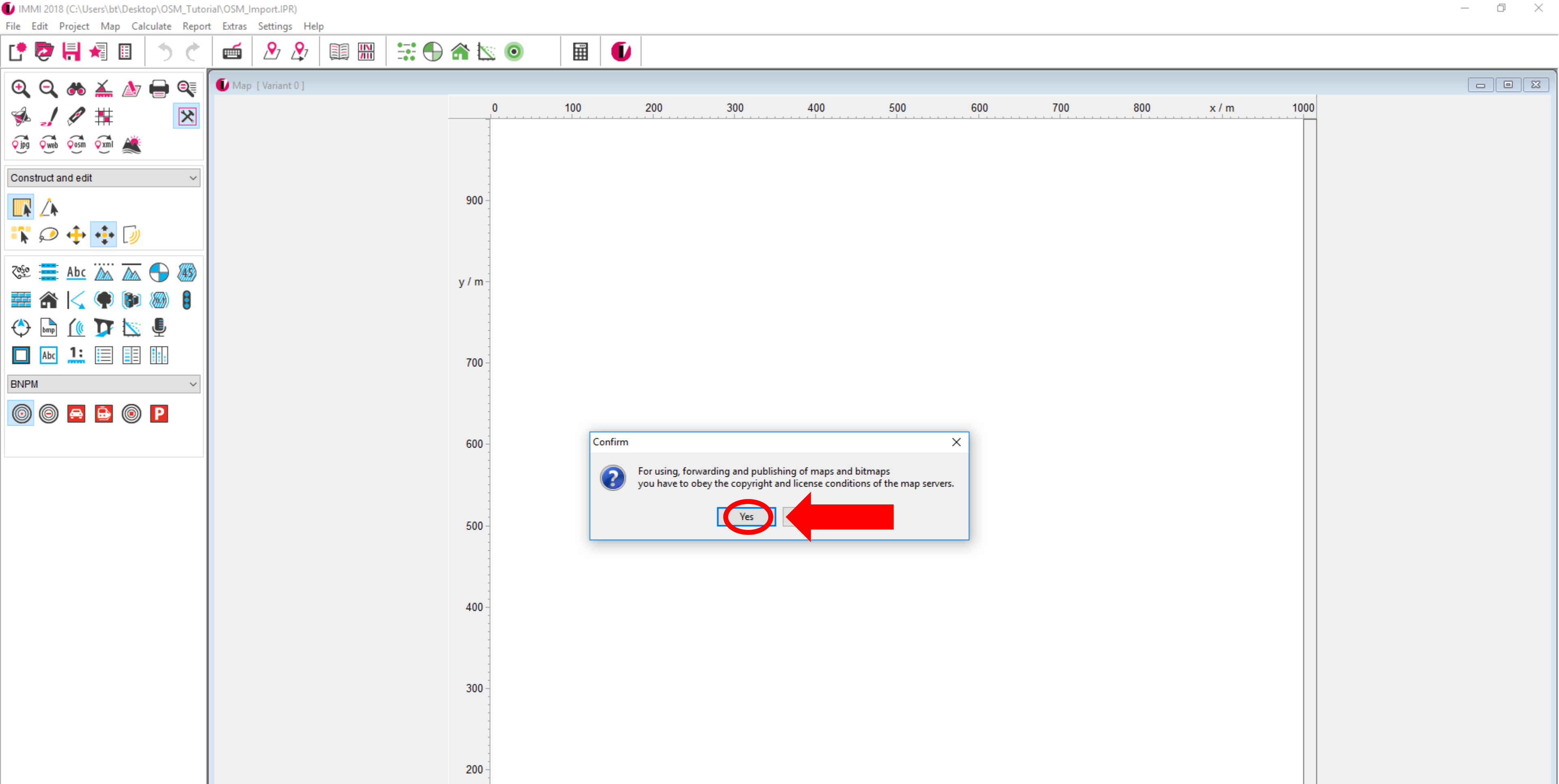

Confirm the appearing copyright dialogue with „Yes“.



This will open a full screen view of OpenStreetMap.



Enter the desired location of the project – in our example „Laerz” – and press „Search”.



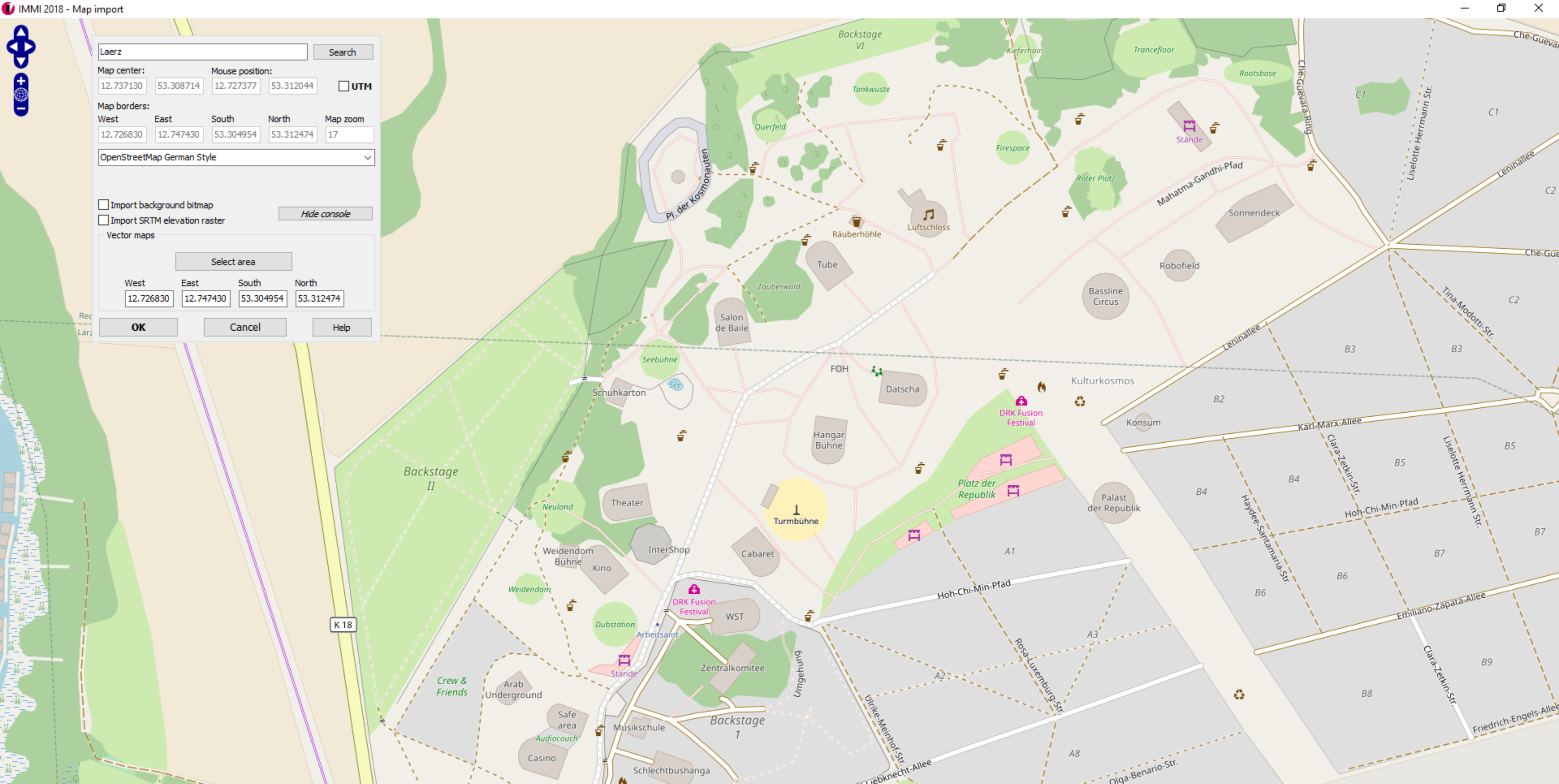

Use the mouse to navigate to the festival area north of Laerz and zoom in to obtain a reasonable work area.

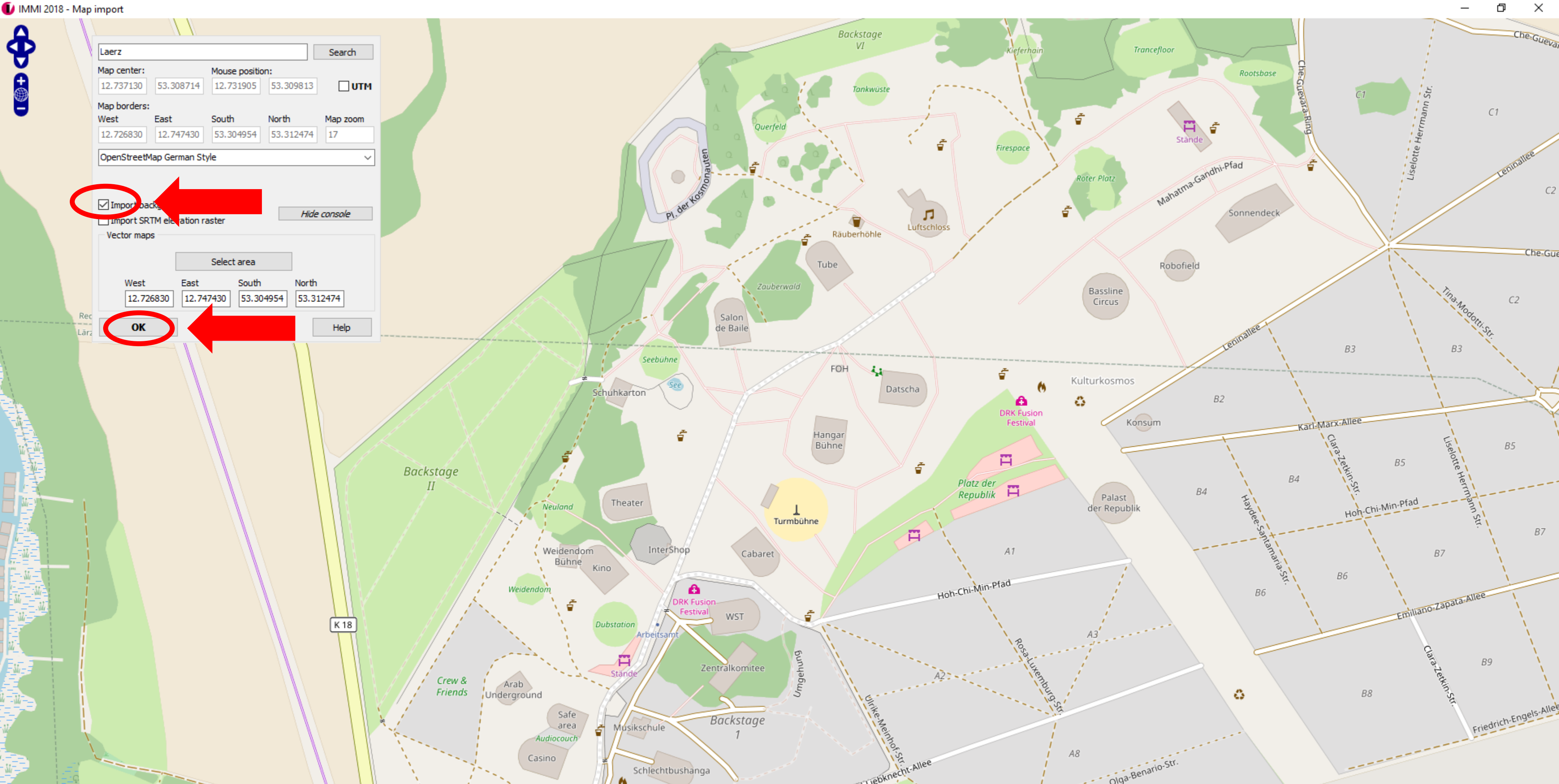

Activate „Import background bitmap“ and confirm with OK.

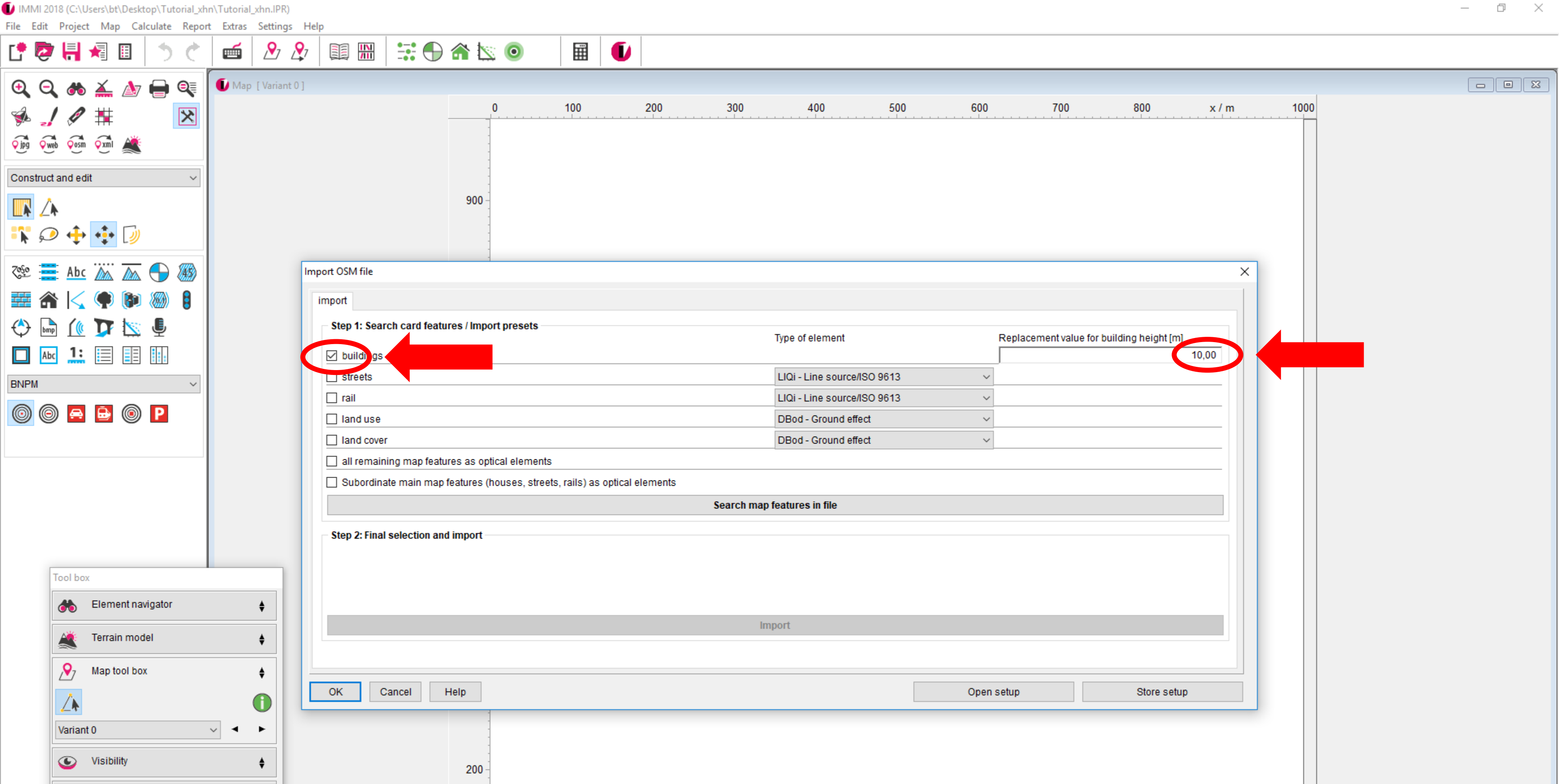

Activate the feature „buildings“ and define a replacement value for the building height of 10 m.

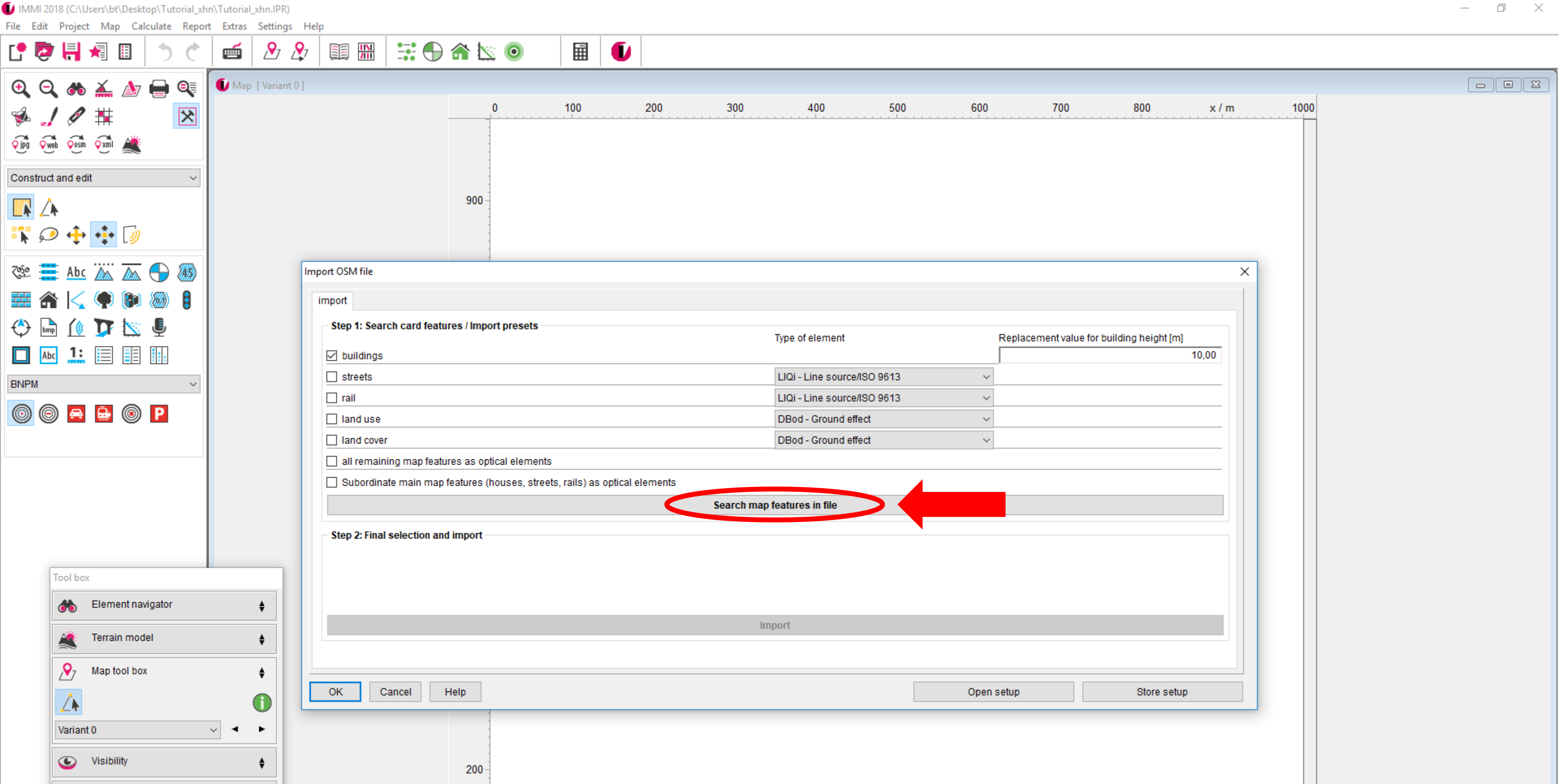

Click „Search map features in file“ in order to scan the downloaded osm-file for buildings.

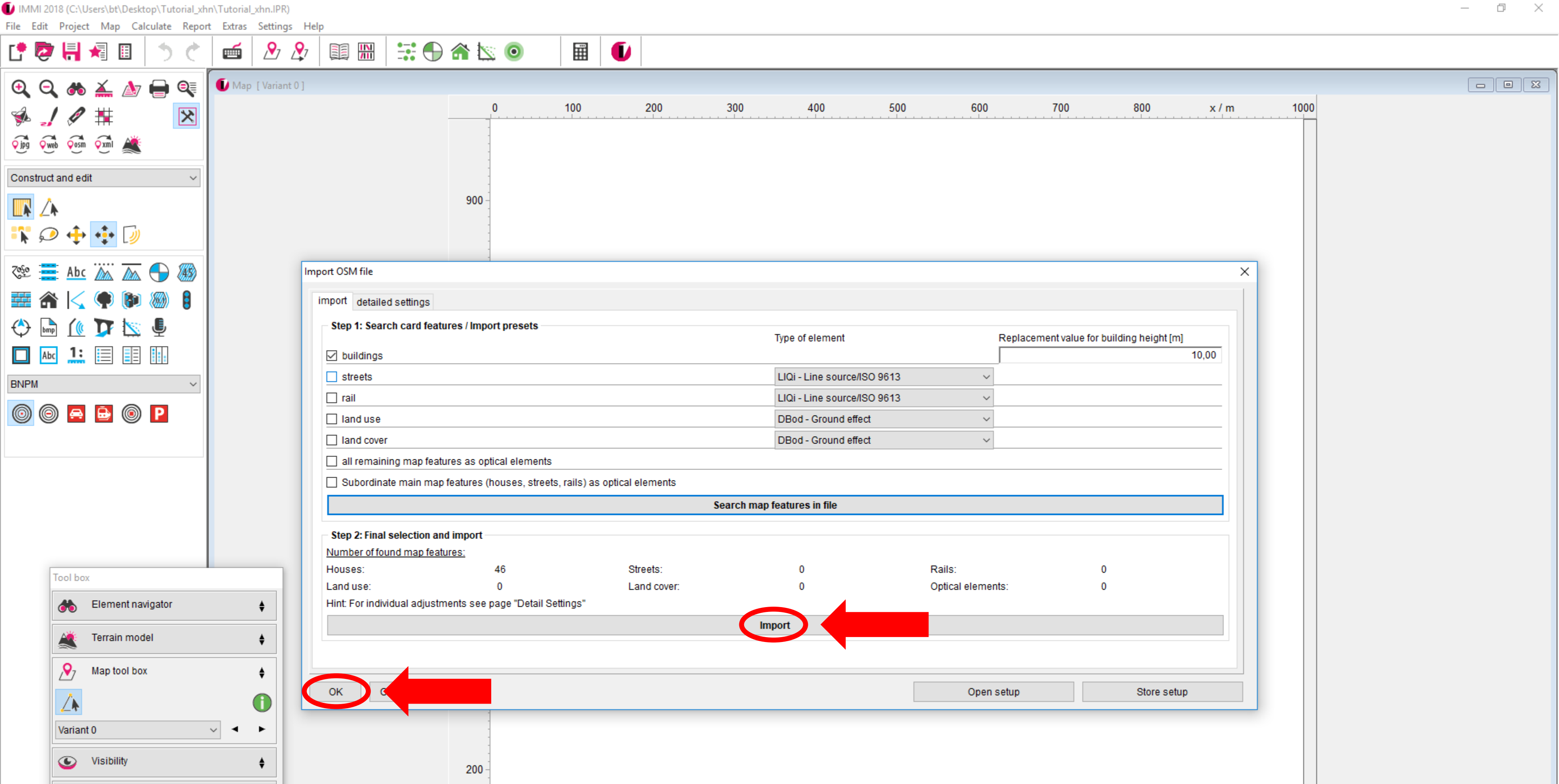

A summary of the detected elements is displayed. Press „Import“ and confirm with „OK“.

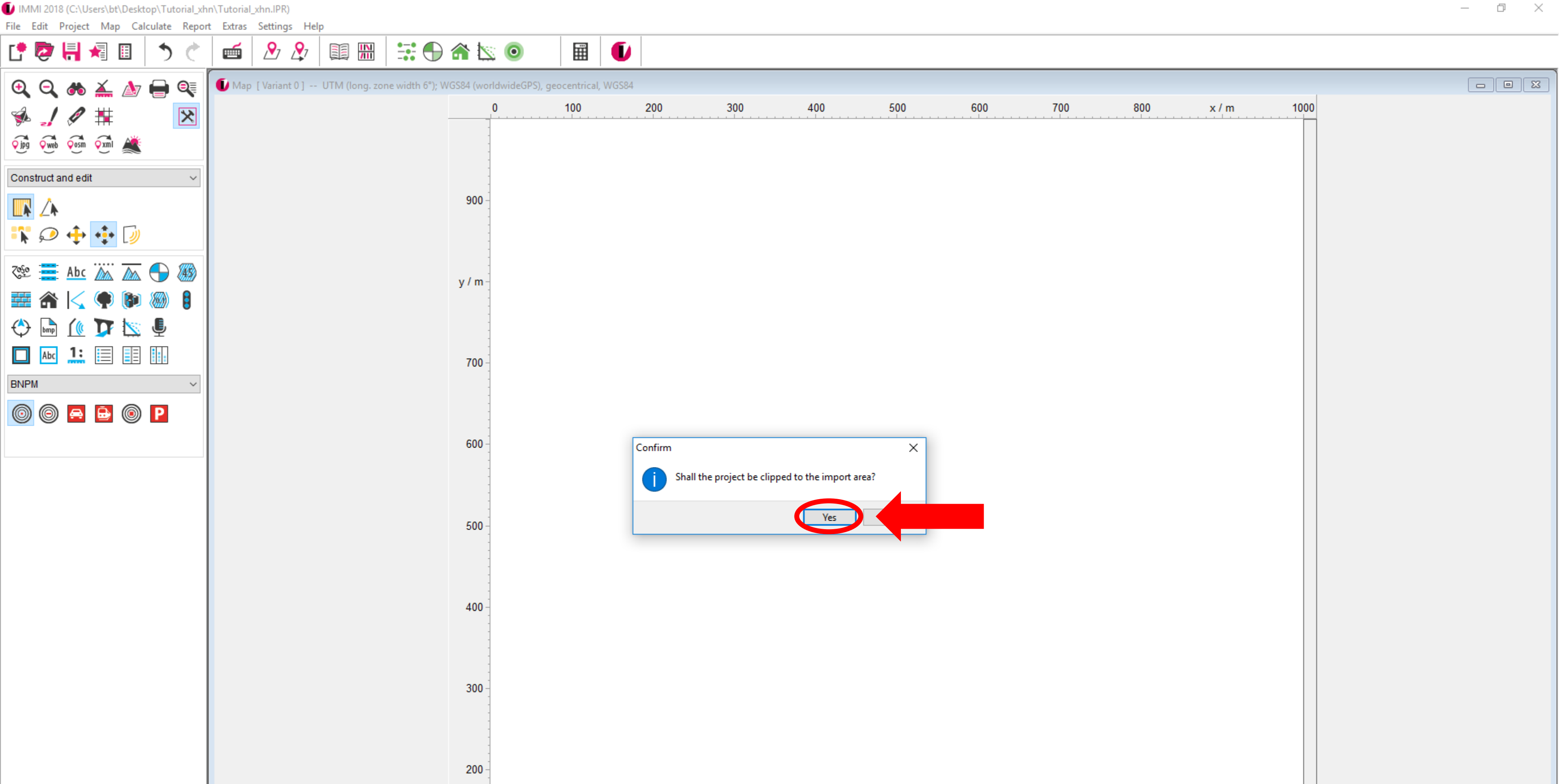

Confirm the appearing dialogue with „Yes“ in order to adjust the work area to the import area.

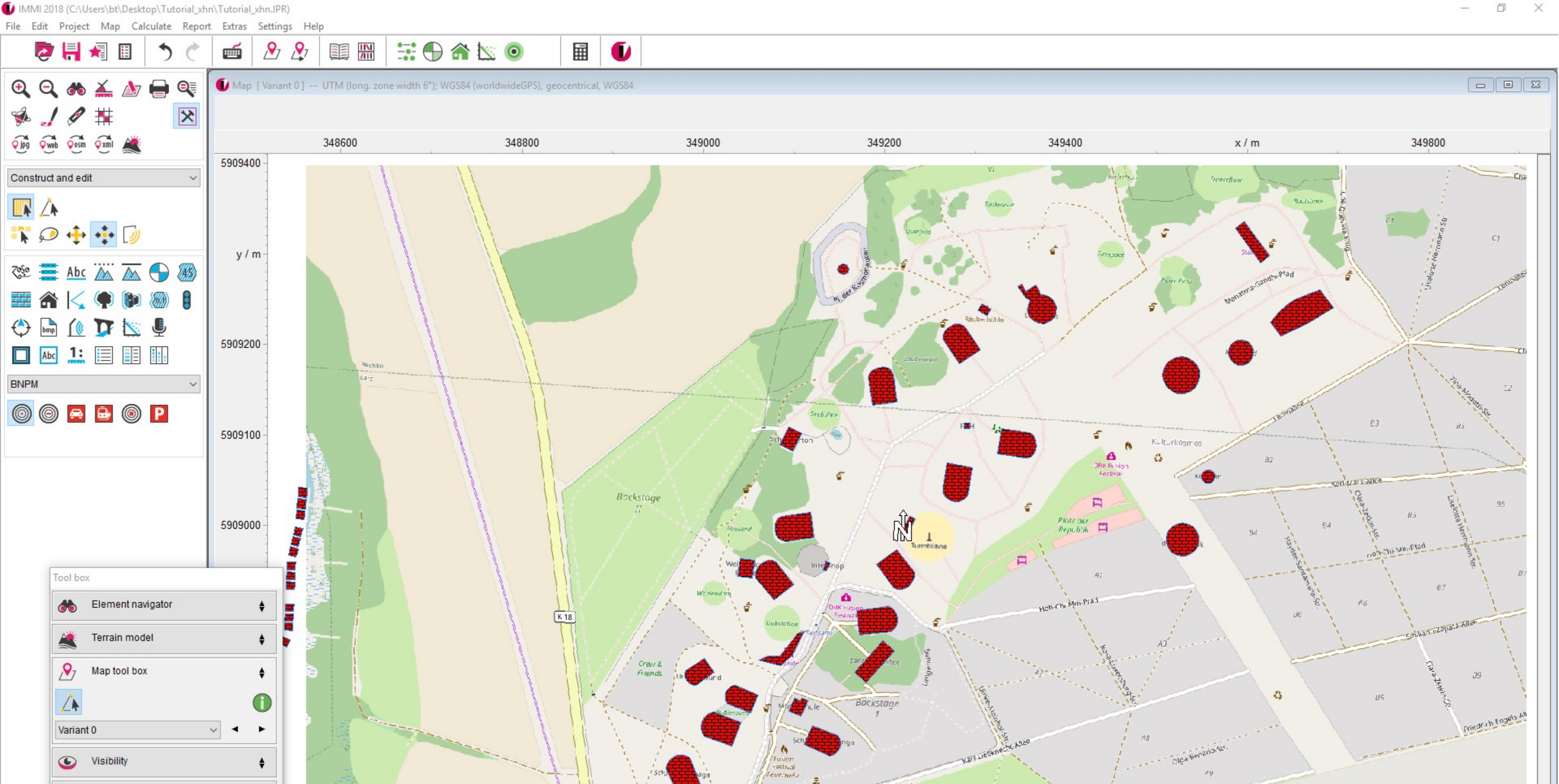

Now the model set up is complete except for the noise sources. In this case we will model loud speaker arrays.

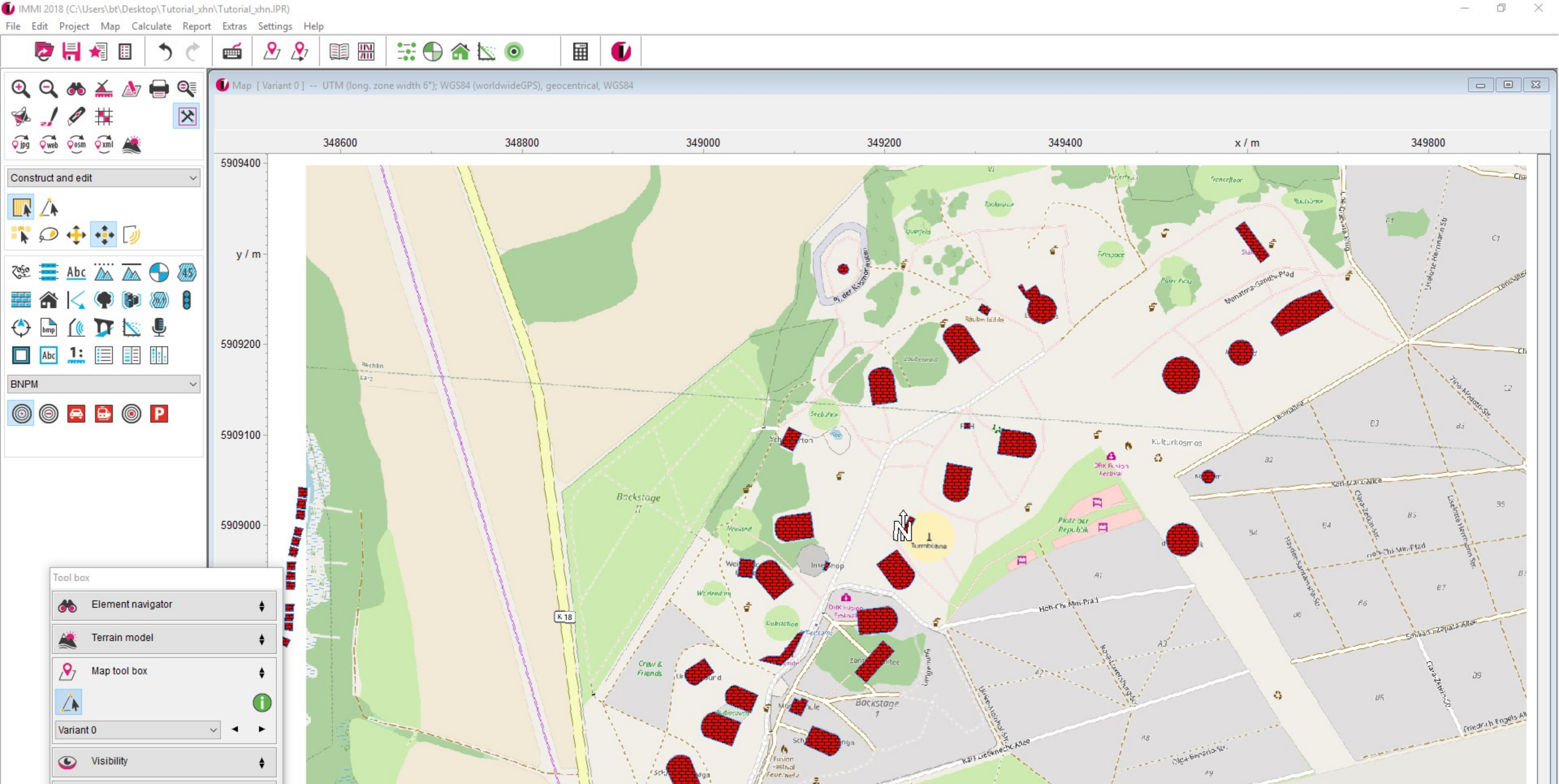

Therefore we need to get information on the ideal setup of the line arrays for our task.

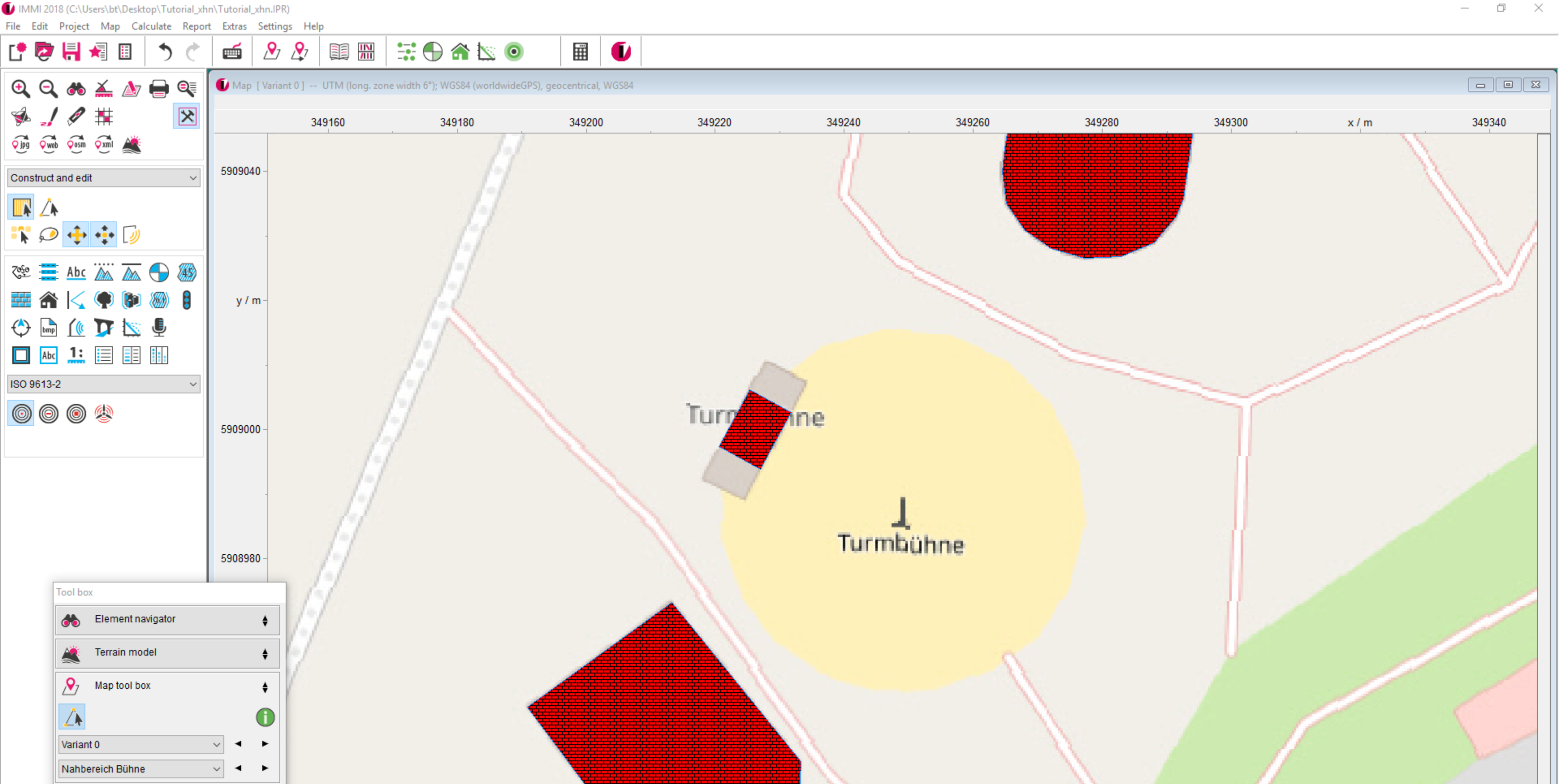

We want to model the electroacoustic system for the central stage in our example. The area for the audience is displayed in dark yellow.

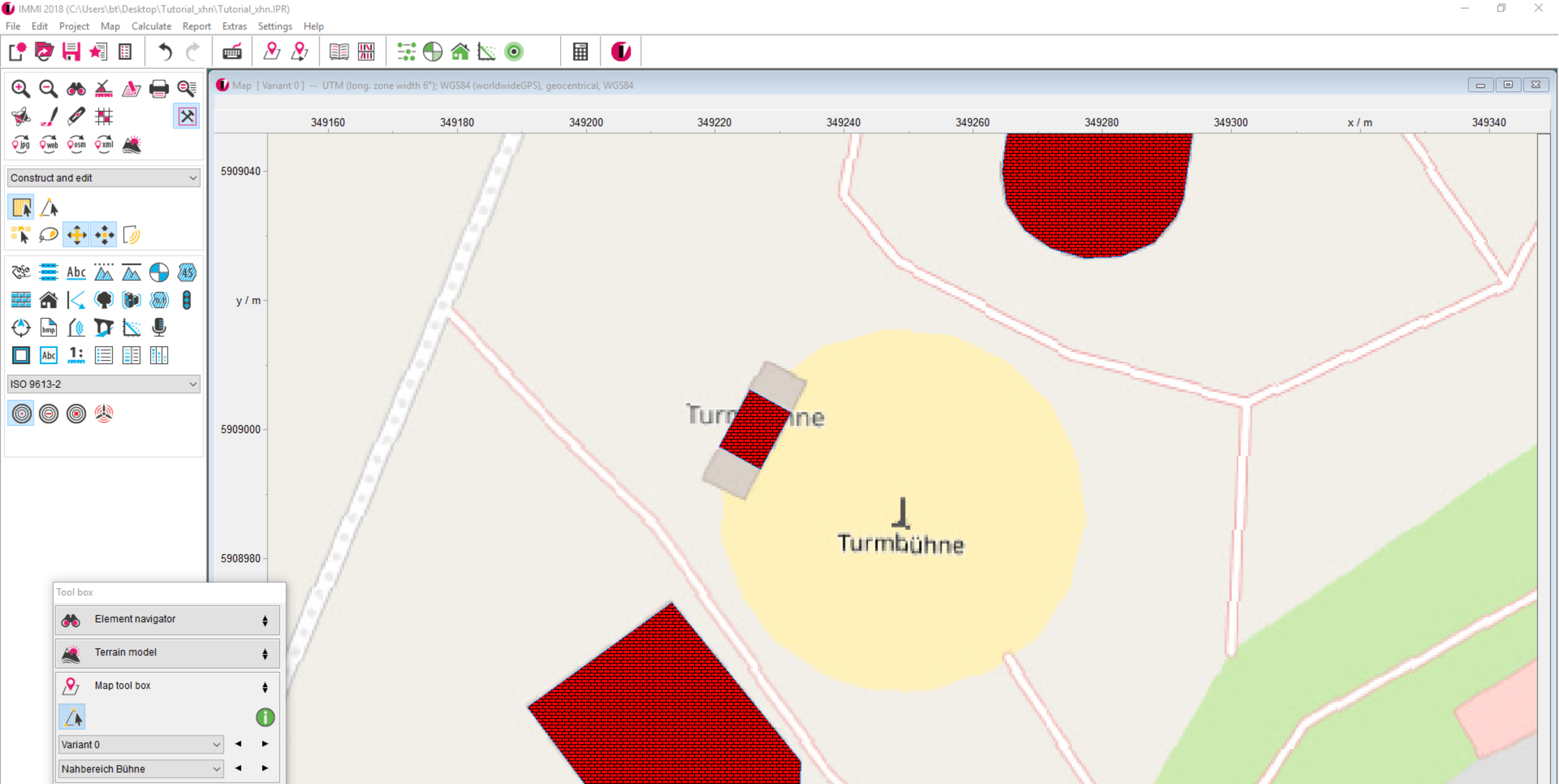

In order to consider the directivity of the loudspeakers in IMMI, the layout of the line arrays has to be designed first.

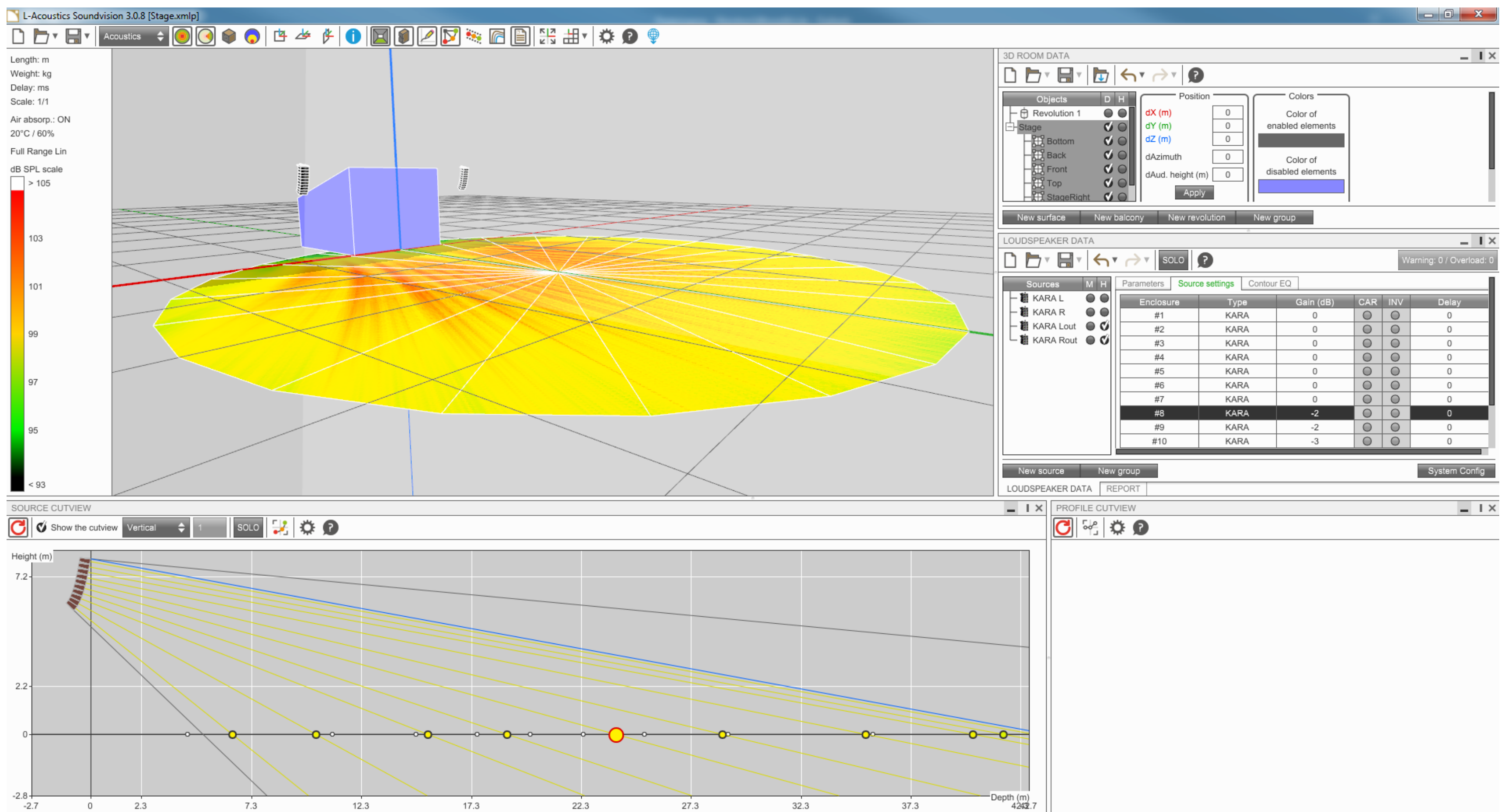

In our example this step is carried out for a setup from L-Acoustics with the software Soundvision.

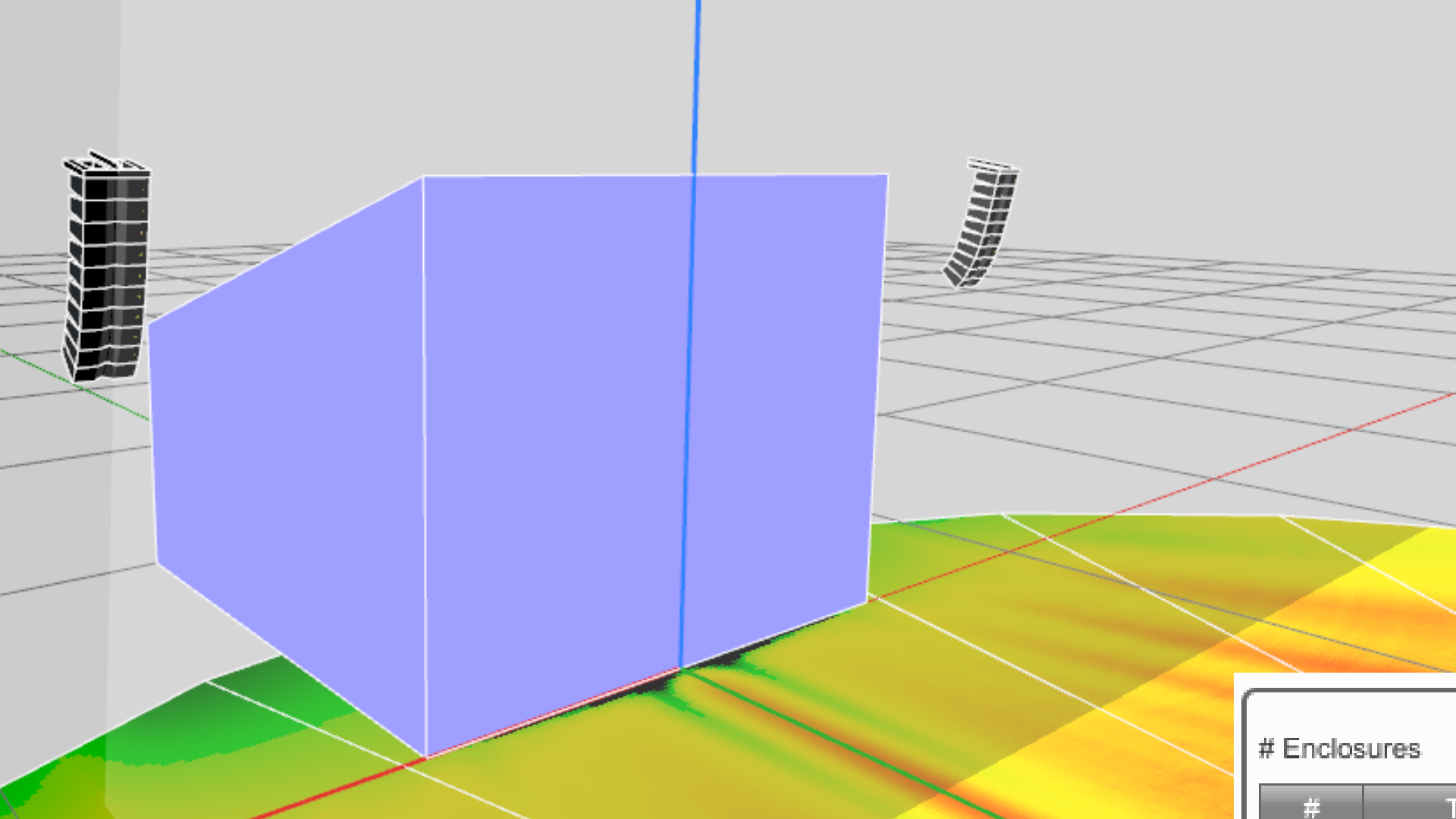

Number of speakers per array

Relative angle

Relative gain

Elements

Enclosures Stacked

#	Type	Angle
	M-BUMP hole A	
#1	KARA	5
#2	KARA	0
#3	KARA	0
#4	KARA	1
#5	KARA	2
#6	KARA	2
#7	KARA	3
#8	KARA	3
#9	KARA	7.5
#10	KARA	10

Type of speaker

Enclosure	Type	Gain (dB)
#1	KARA	0
#2	KARA	0
#3	KARA	0
#4	KARA	0
#5	KARA	0
#6	KARA	0
#7	KARA	0
#8	KARA	-2
#9	KARA	-2
#10	KARA	-3

For calculating and exporting the directivity, the above parameters are generated within Soundvision.

1. Start EASE Speaker Lab Pro



2. Import the loudspeaker configuration file („GLL“)

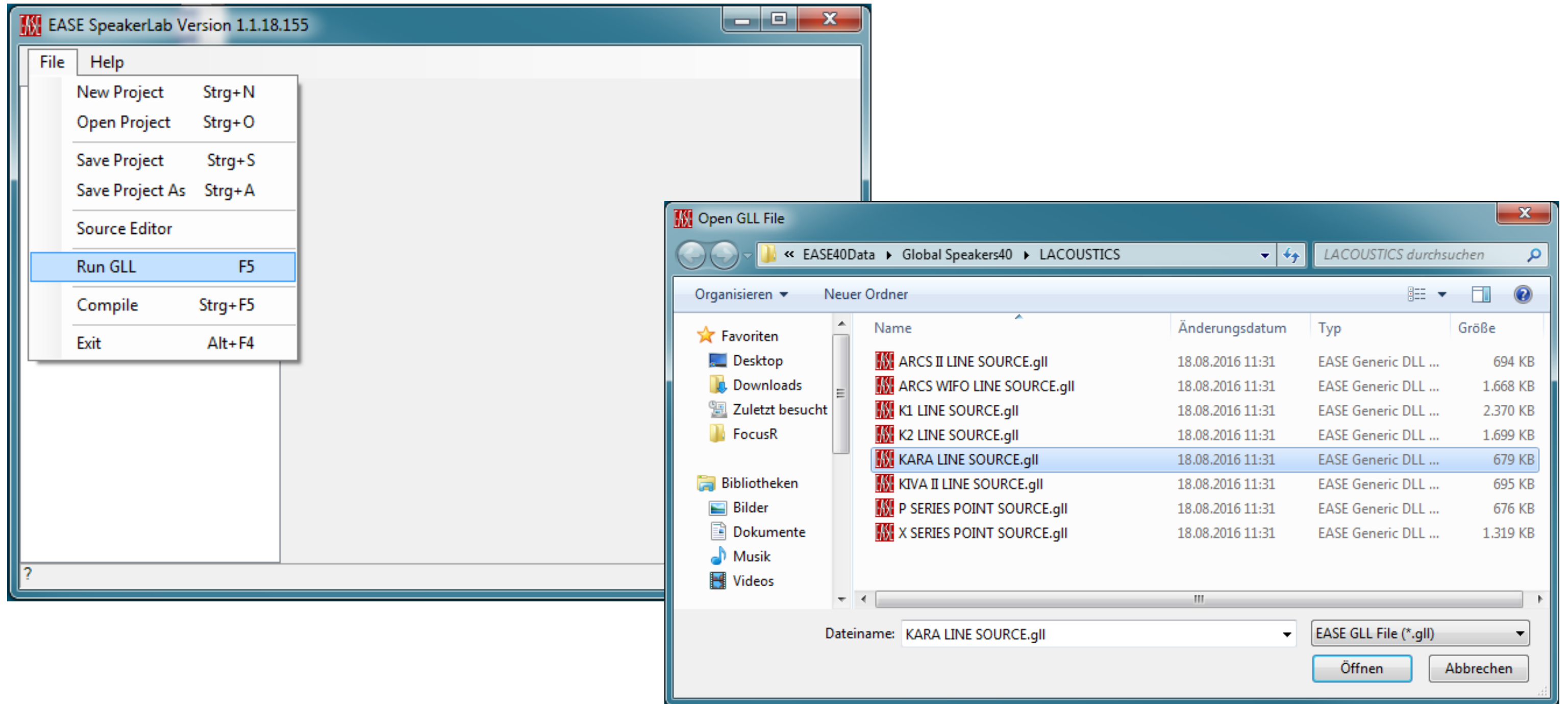

In the next step these parameters are used to calculate and export the directivity with the software EASE Speaker Lab Pro.

1. Start EASE Speaker Lab Pro



2. Import the loudspeaker configuration file („GLL“)

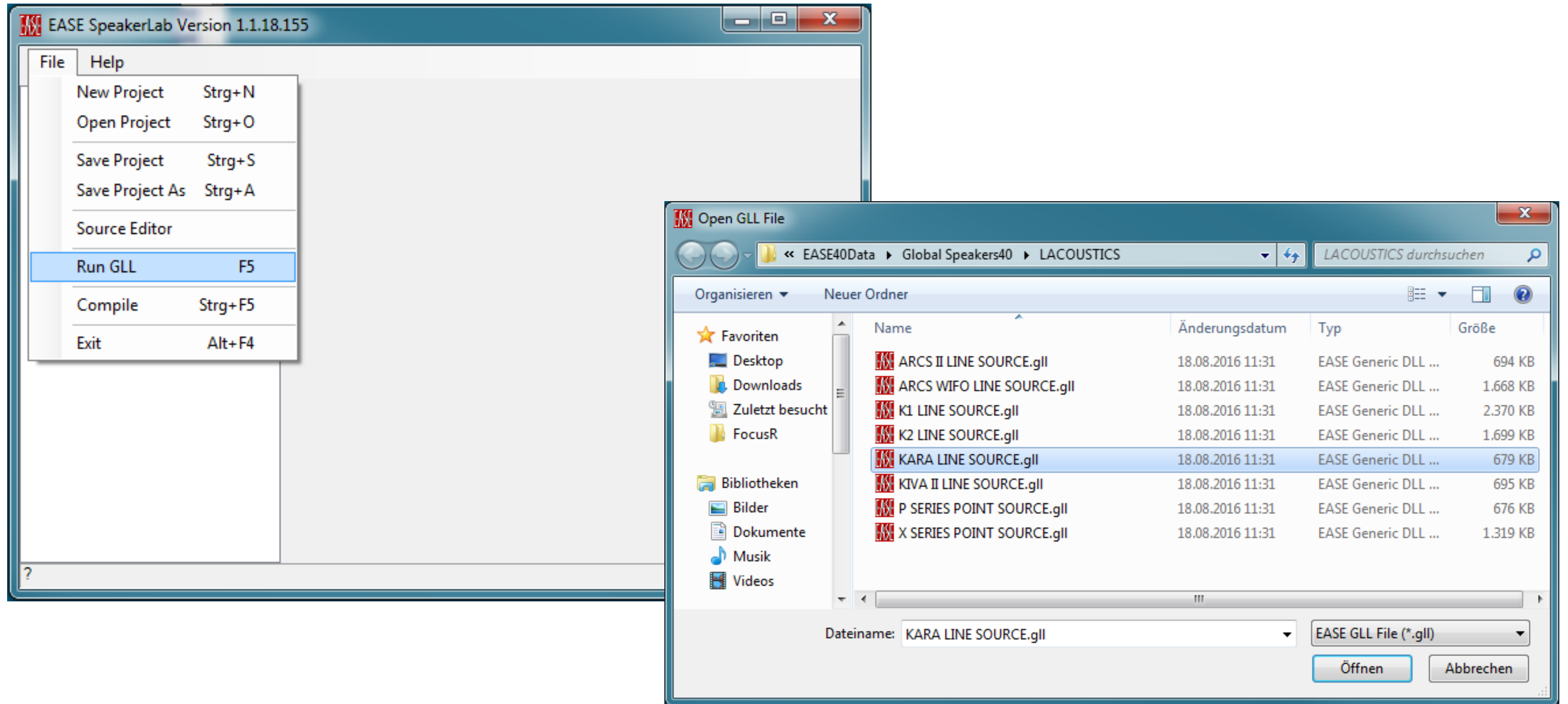

The required GLL files can usually be obtained from the manufacturer's website.

3. Transfer of the speaker configuration to EASE Speaker Lab

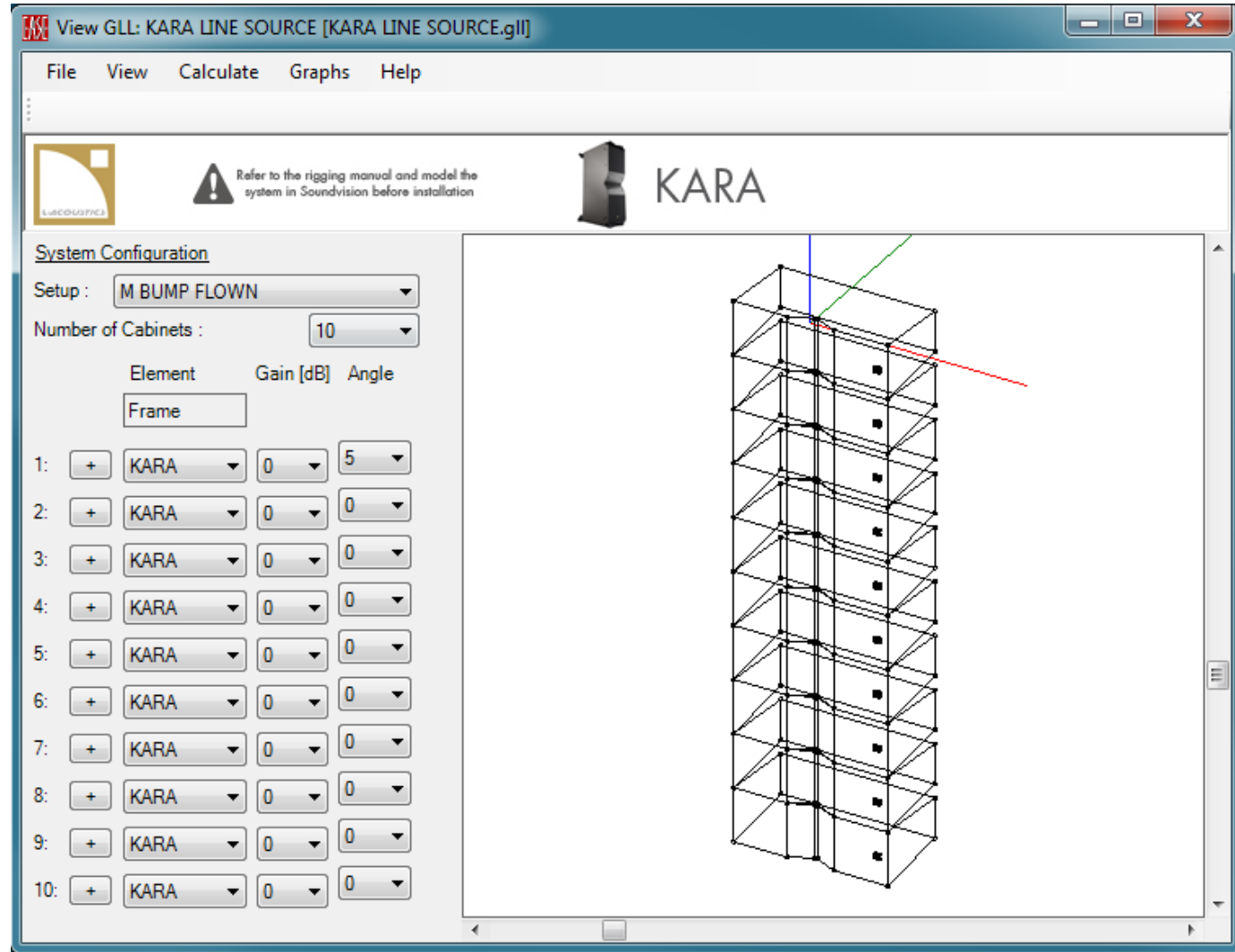

#	Type	Angle
	M-BUMP hole A	
#1	KARA	5
#2	KARA	0
#3	KARA	0
#4	KARA	1
#5	KARA	2
#6	KARA	2
#7	KARA	3
#8	KARA	3
#9	KARA	7.5
#10	KARA	10

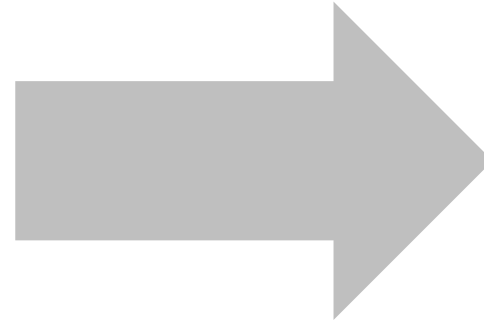

Enclosure	Type	Gain (dB)
#1	KARA	0
#2	KARA	0
#3	KARA	0
#4	KARA	0
#5	KARA	0
#6	KARA	0
#7	KARA	0
#8	KARA	-2
#9	KARA	-2
#10	KARA	-3

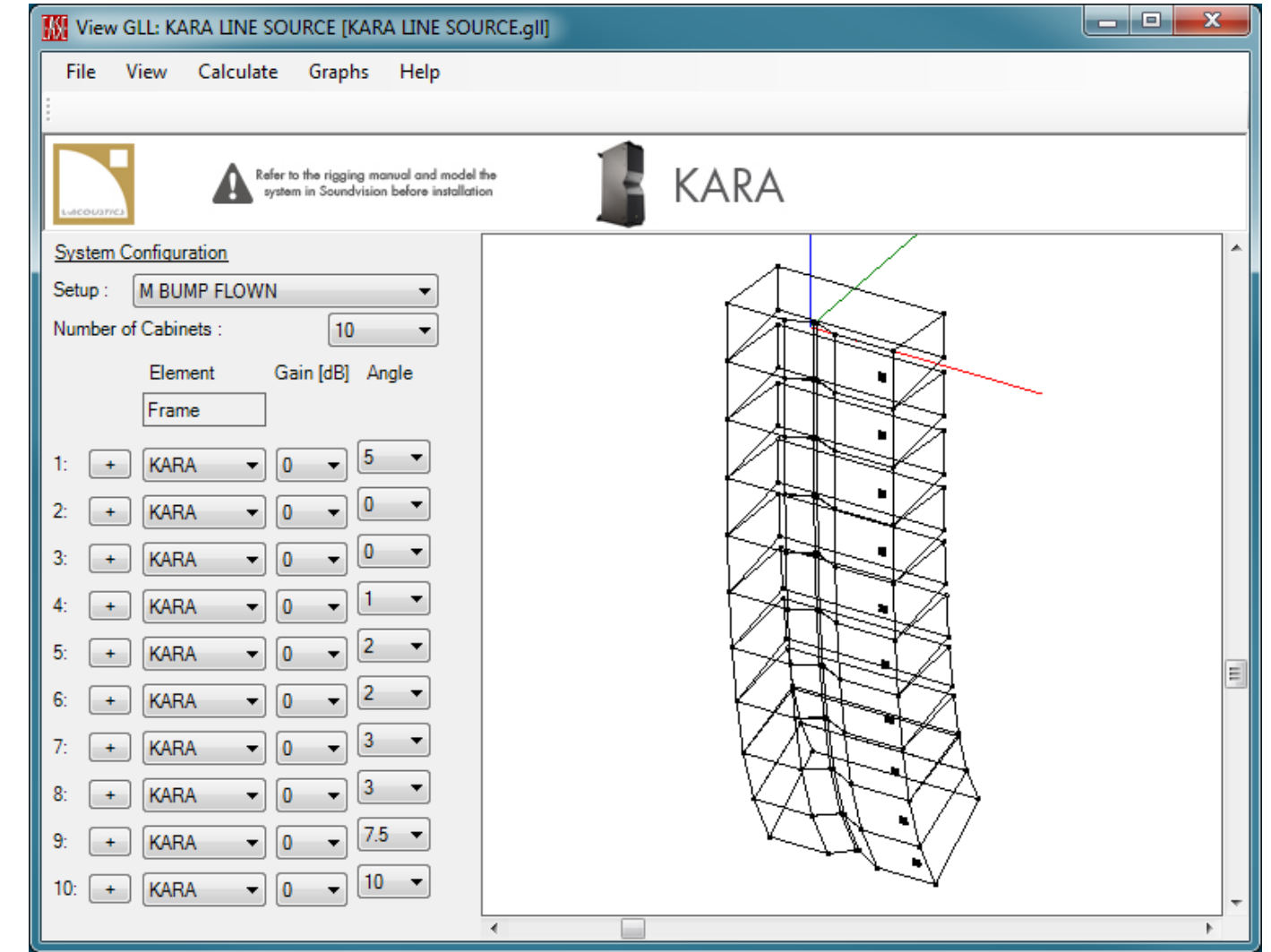

By introducing the parameters from Soundvision (see 3 slides before) to EASE Speaker Lab Pro, the complete setup is defined here.

4. Calculation of the directivity of the point source

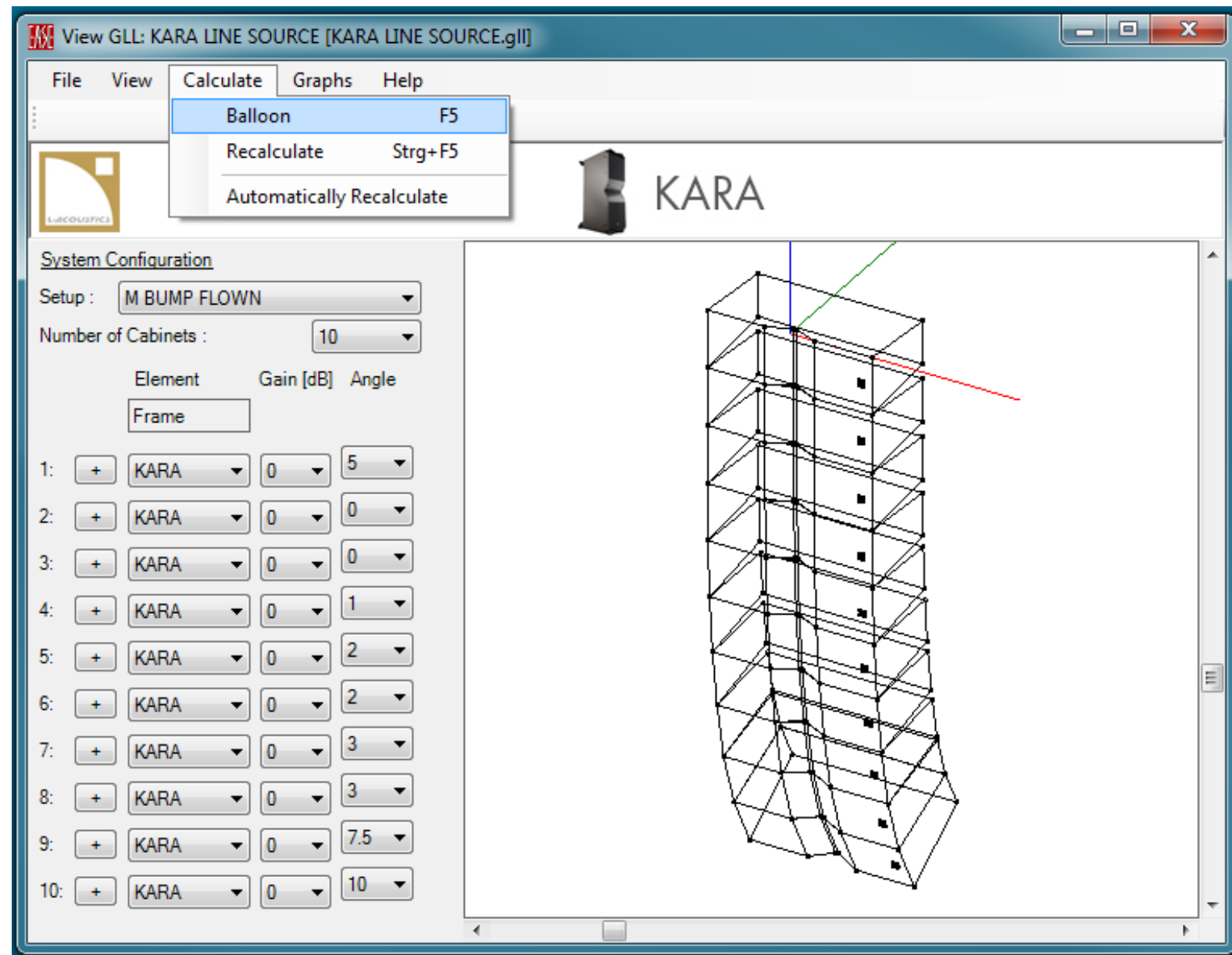

Resolution: Intermediate (5°)

Distance = 100 m

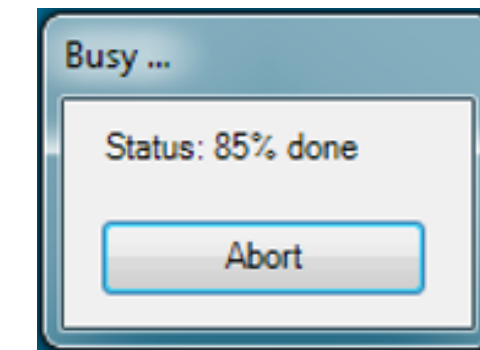
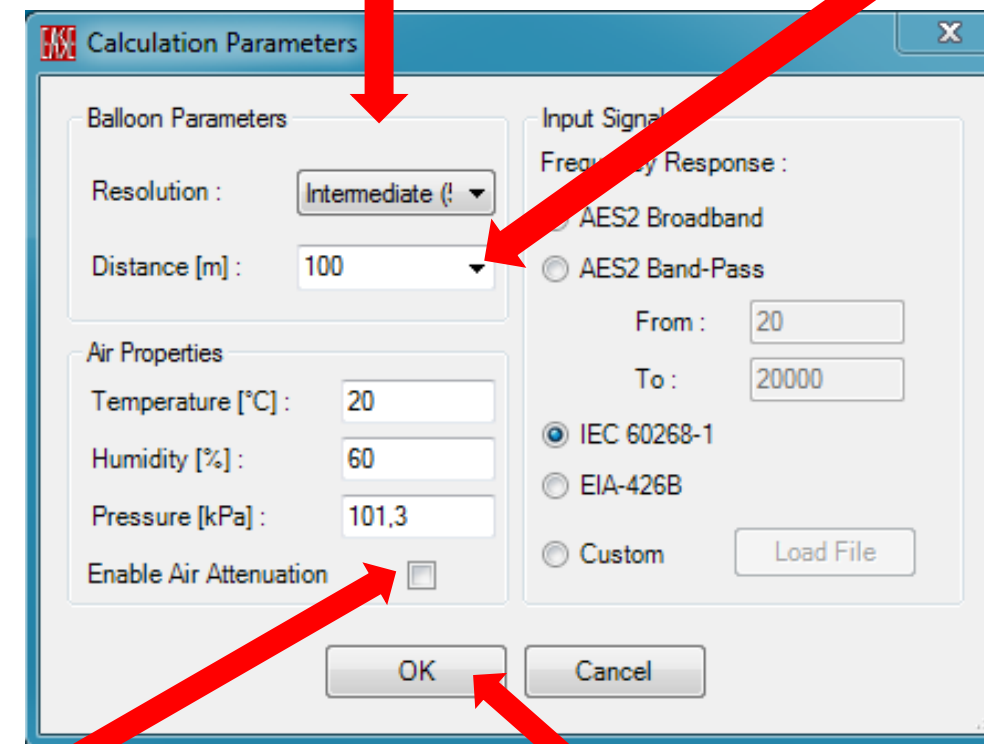

Disable air attenuation! (considered in IMMI)

Start calculation

Then the directivity for the point source in IMMI is calculated within EASE Speaker Lab Pro in the menu „Calculate/Balloon“.

5. Result: display of the directivity as balloon.
Ready for export...

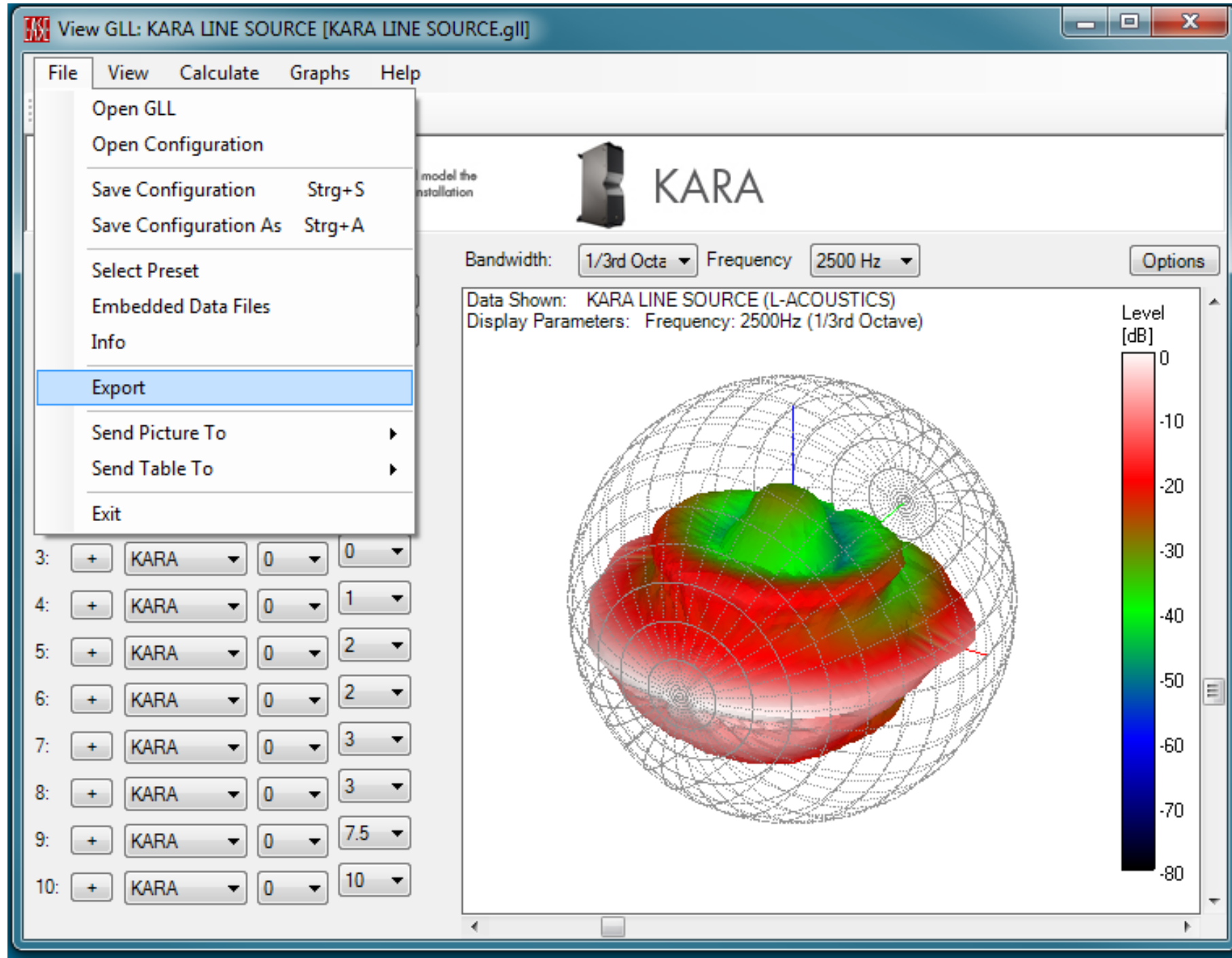

Export as xhn-file

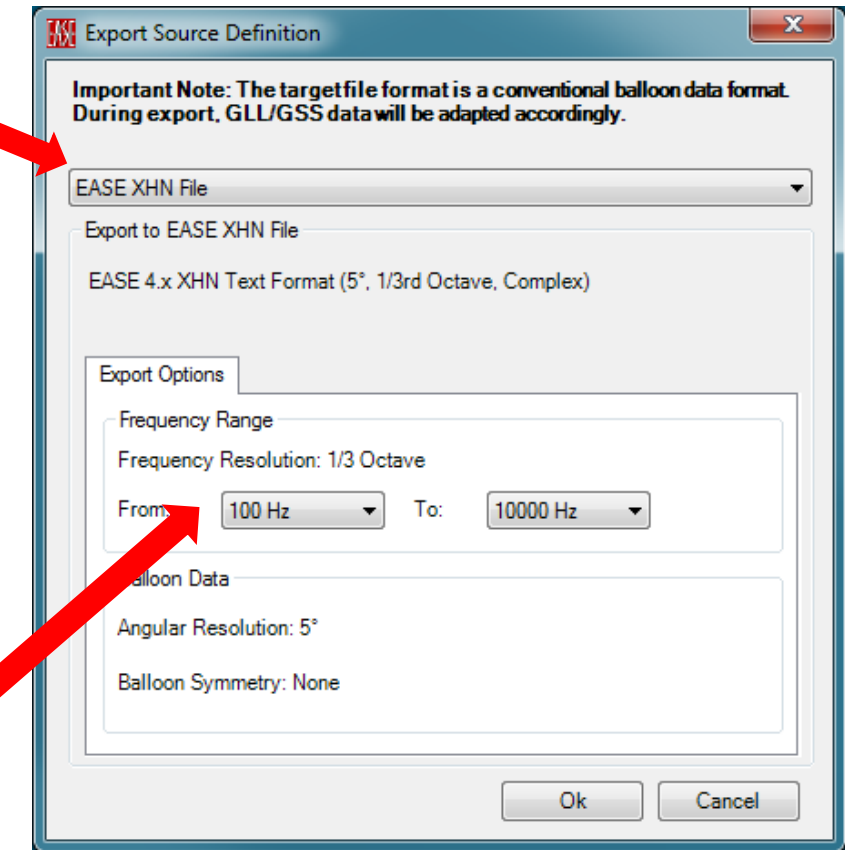

Frequency range = default

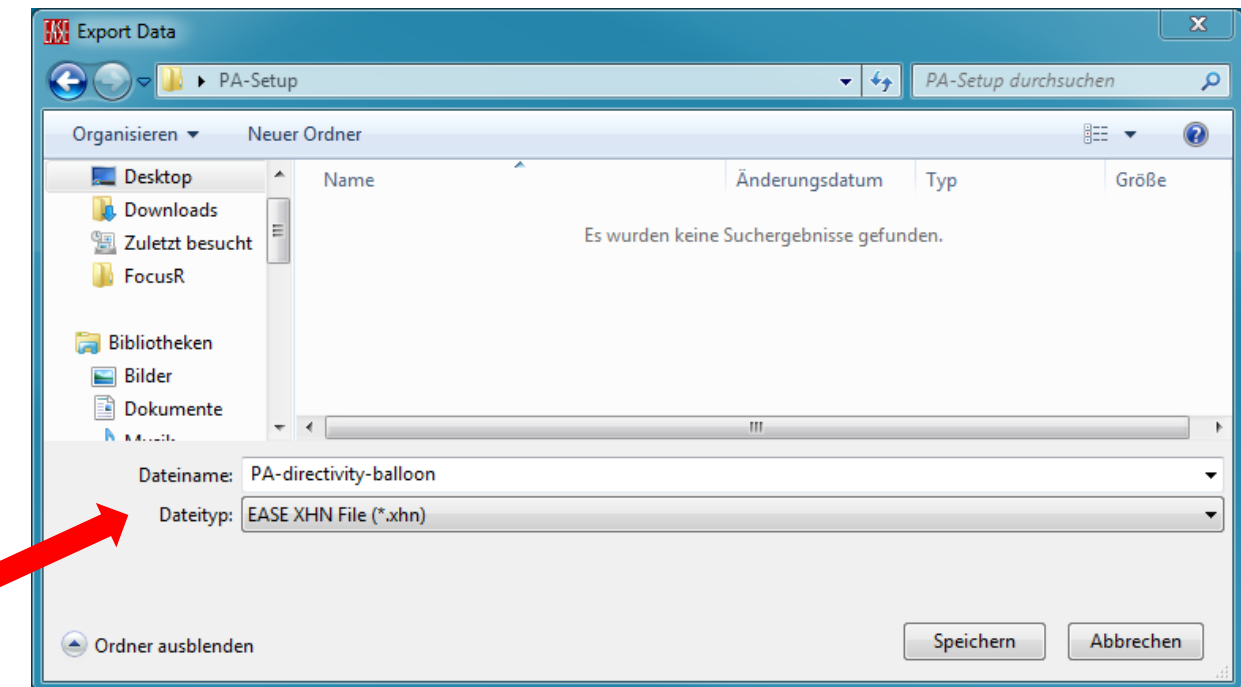

Select path and file name

The directivity is displayed as a balloon and it can now be exported as .xhn-file.

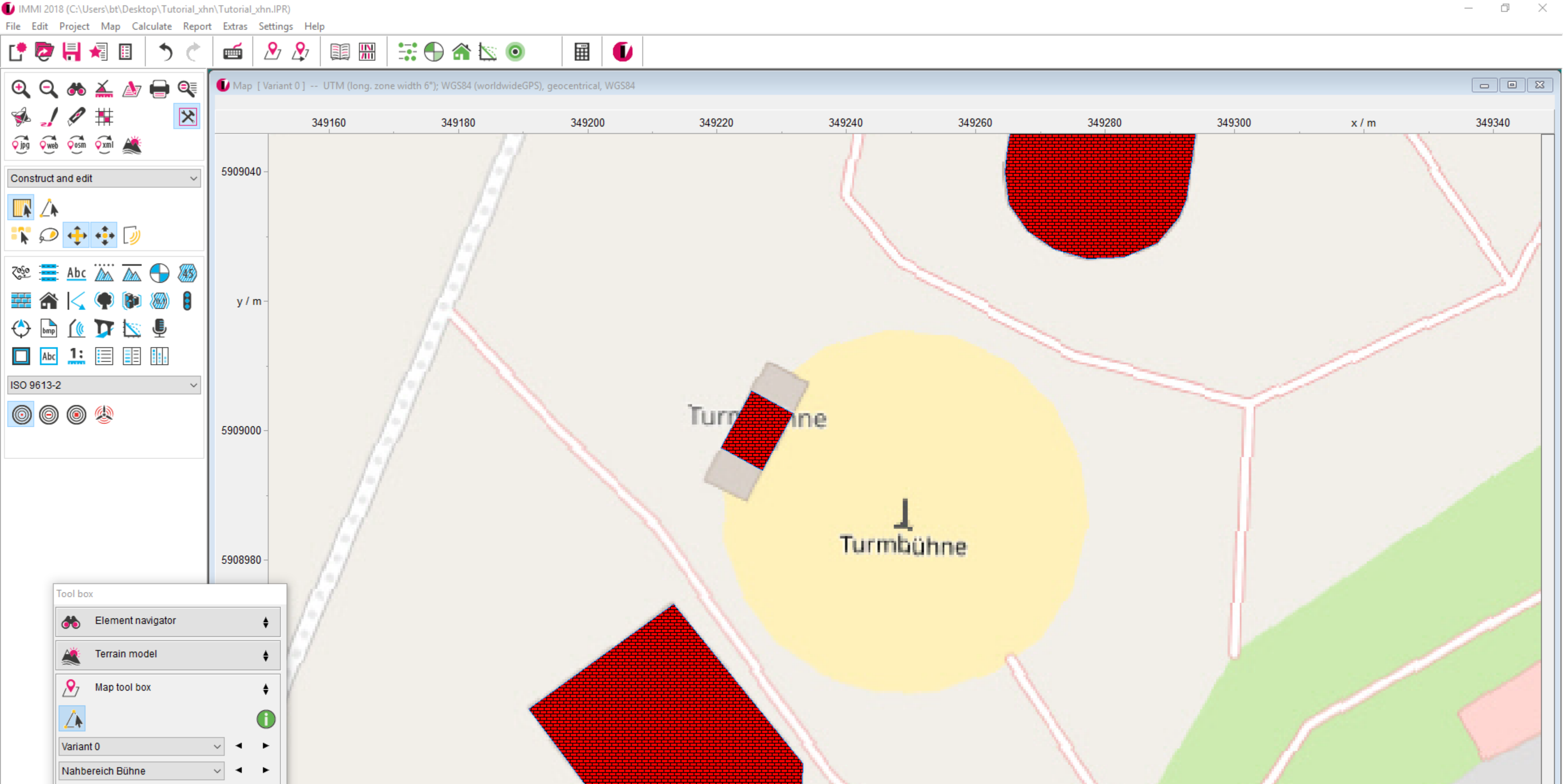

Back in the IMMI project, the first step is to model the line arrays as point sources according to ISO 9613-2 at the center stage.

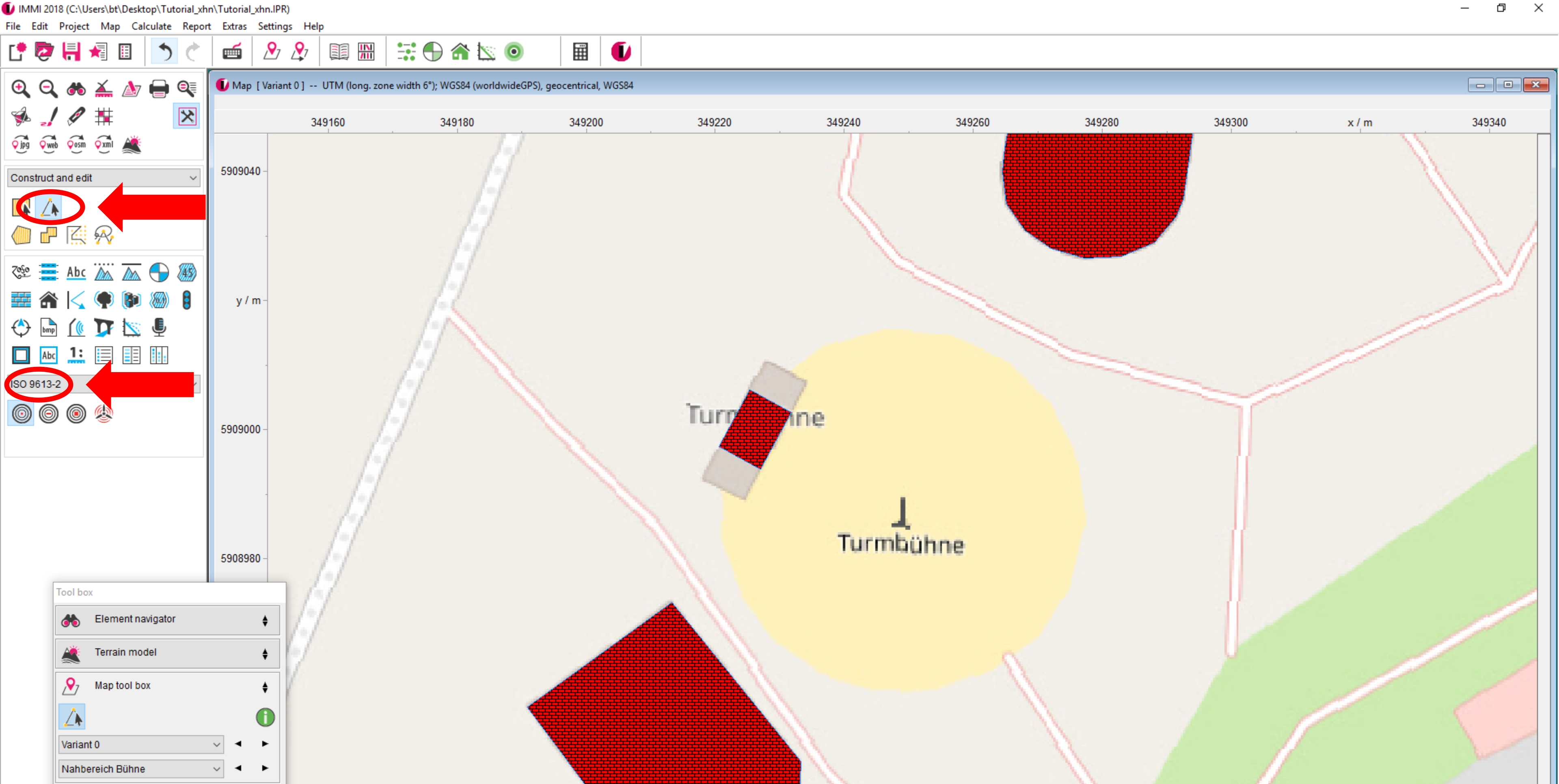

Therefore choose the „draw element“ tool and change to the ISO 9613-2 element library.

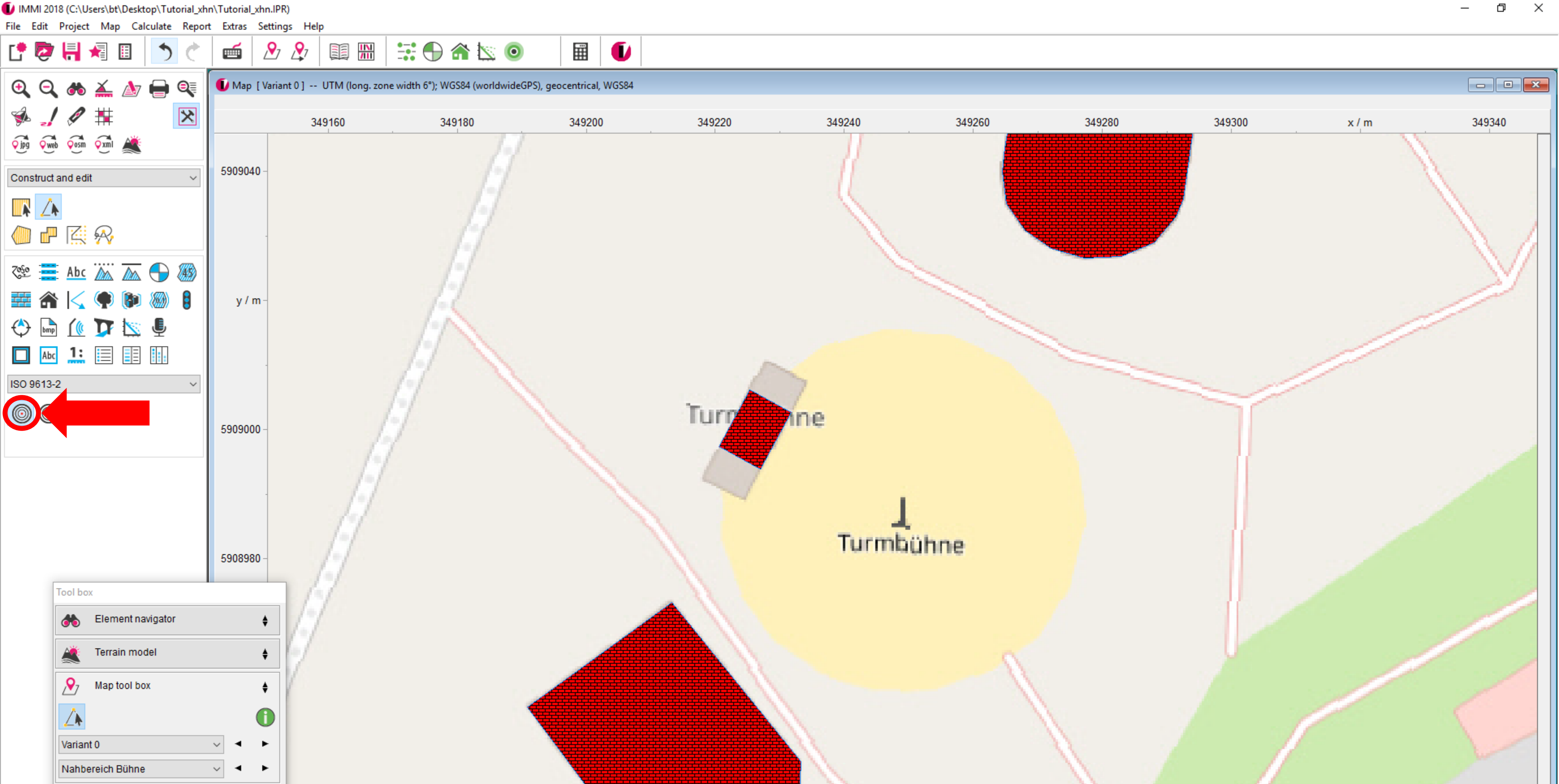

Please use the point source according to ISO 9613-2 in order to model the line arrays and place them at the respective positions.

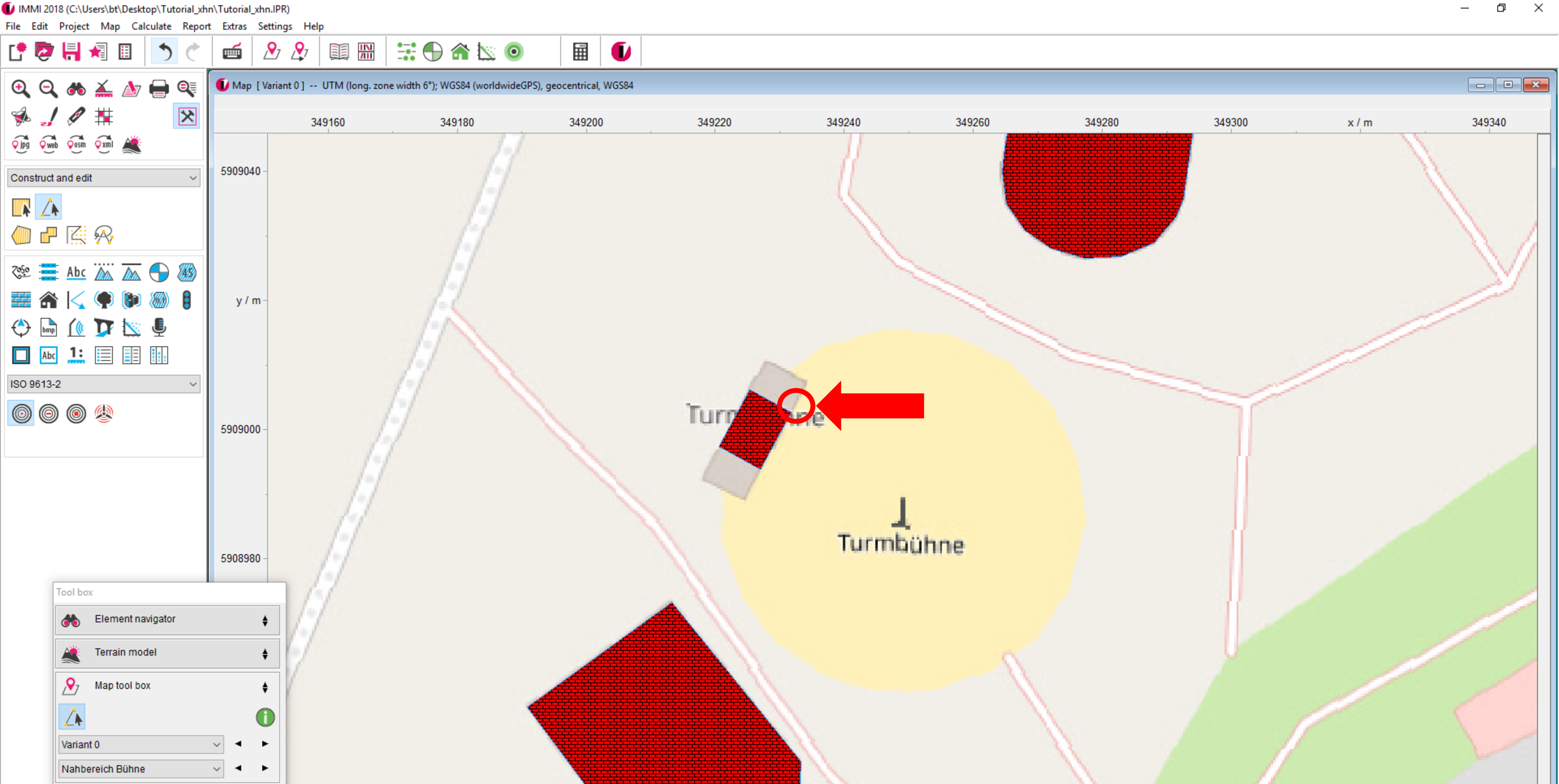

First we model the one on the left side of the stage. After clicking the position with left mouse button, the input dialogue opens.

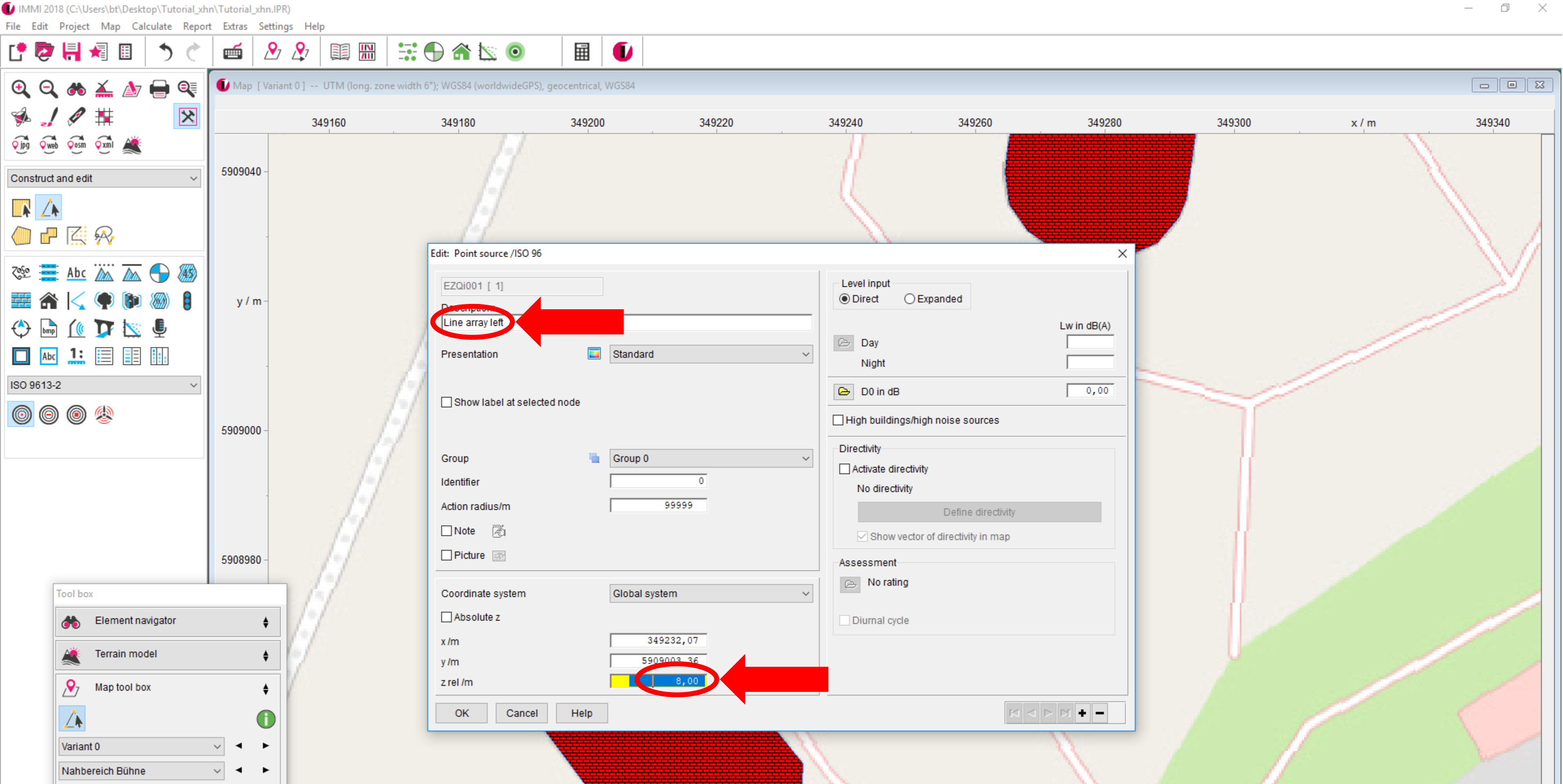

Type in the element name and set the value for the height according to the parameters from Soundvision.

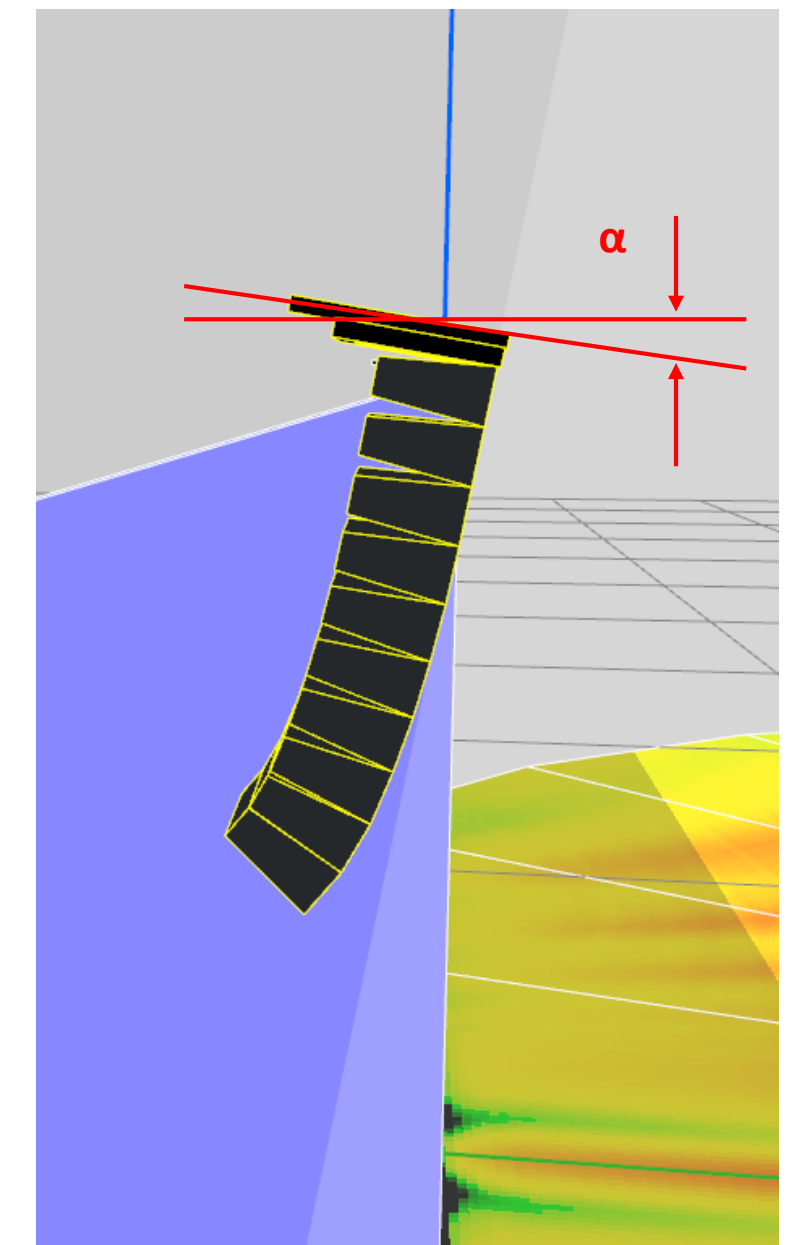
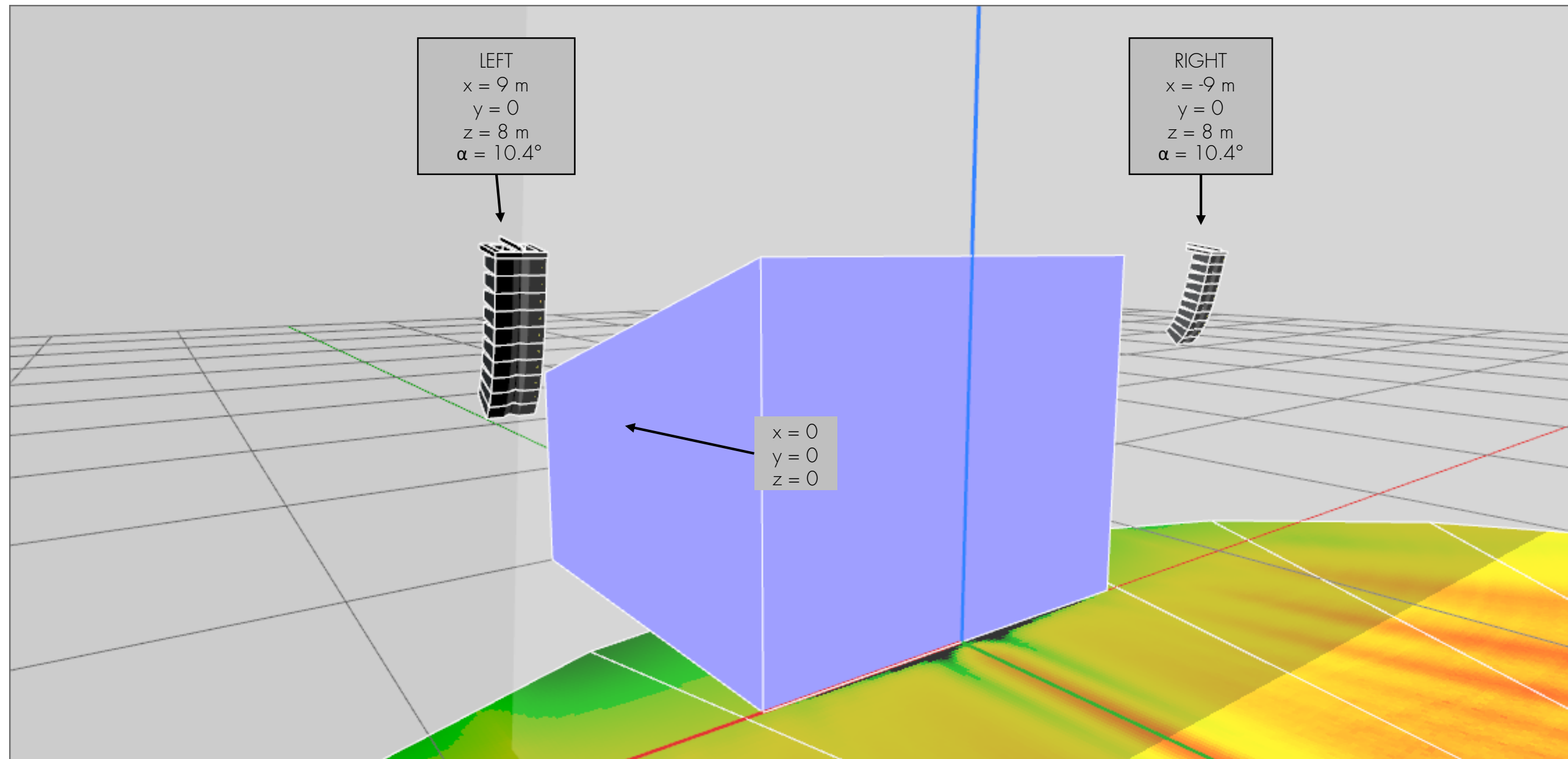

The angle α will be needed later.

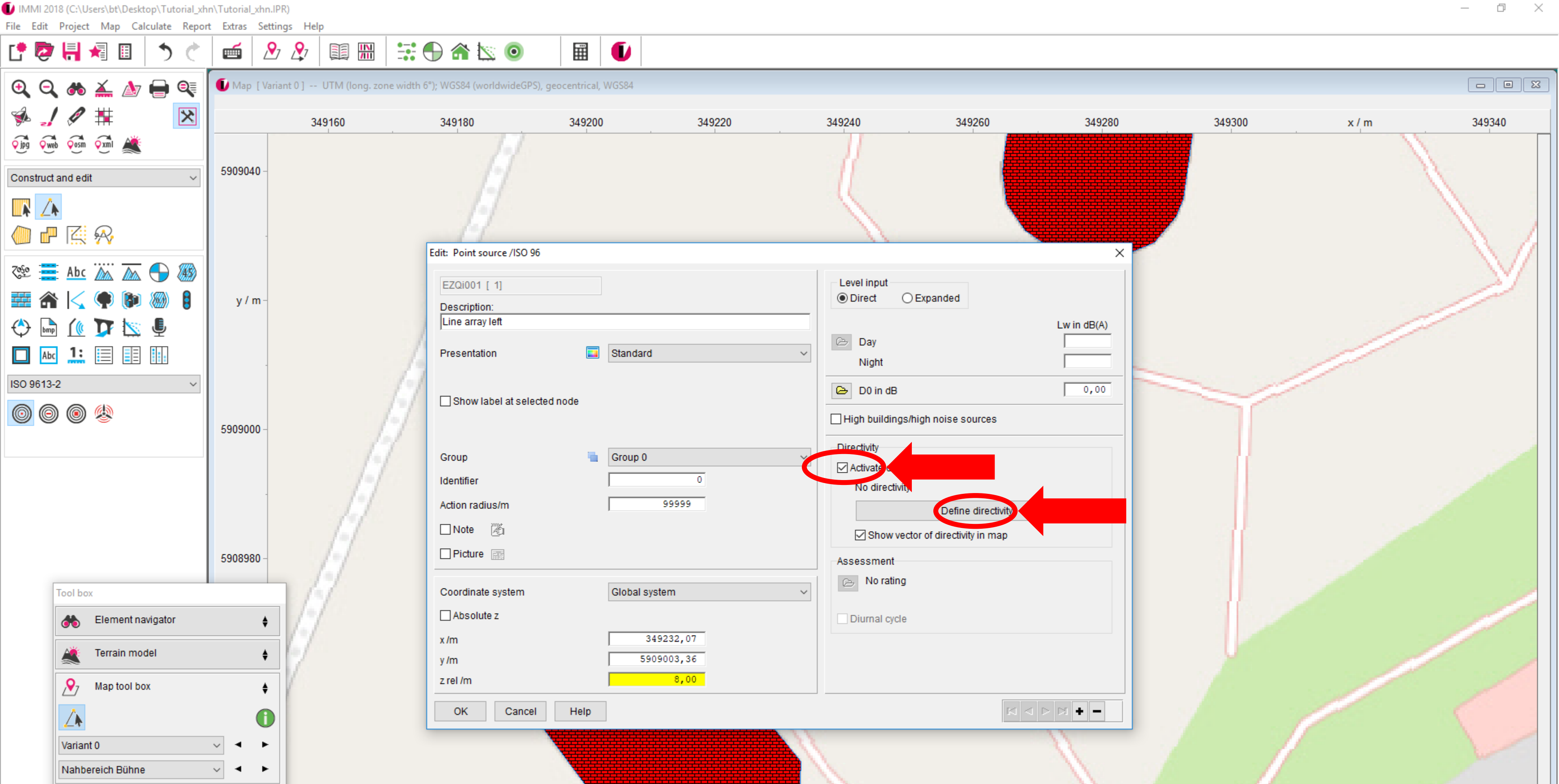

Activate directivity and enter the respective dialogue.

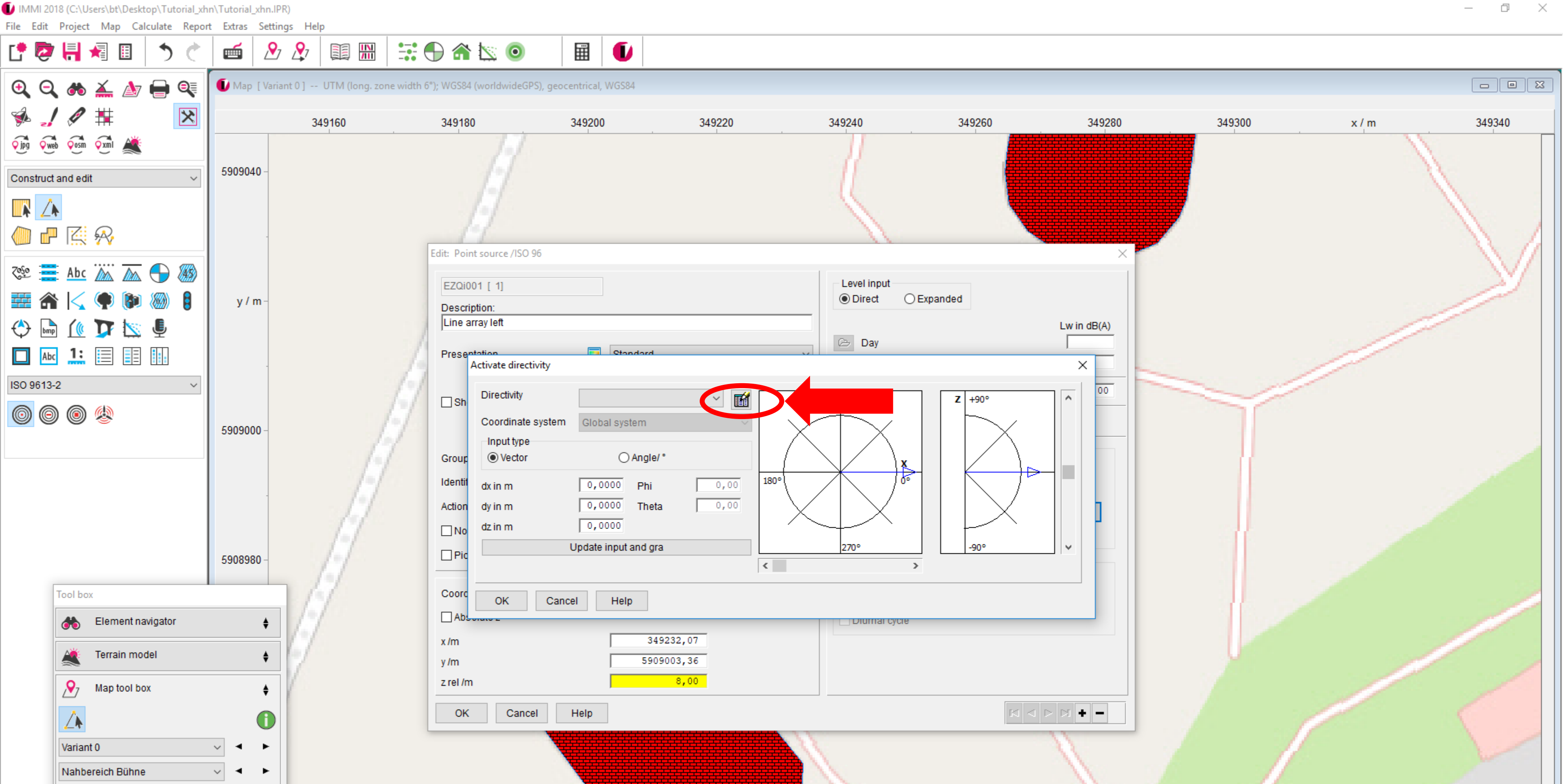

Enter the dialogue to edit the reference list of directivities.

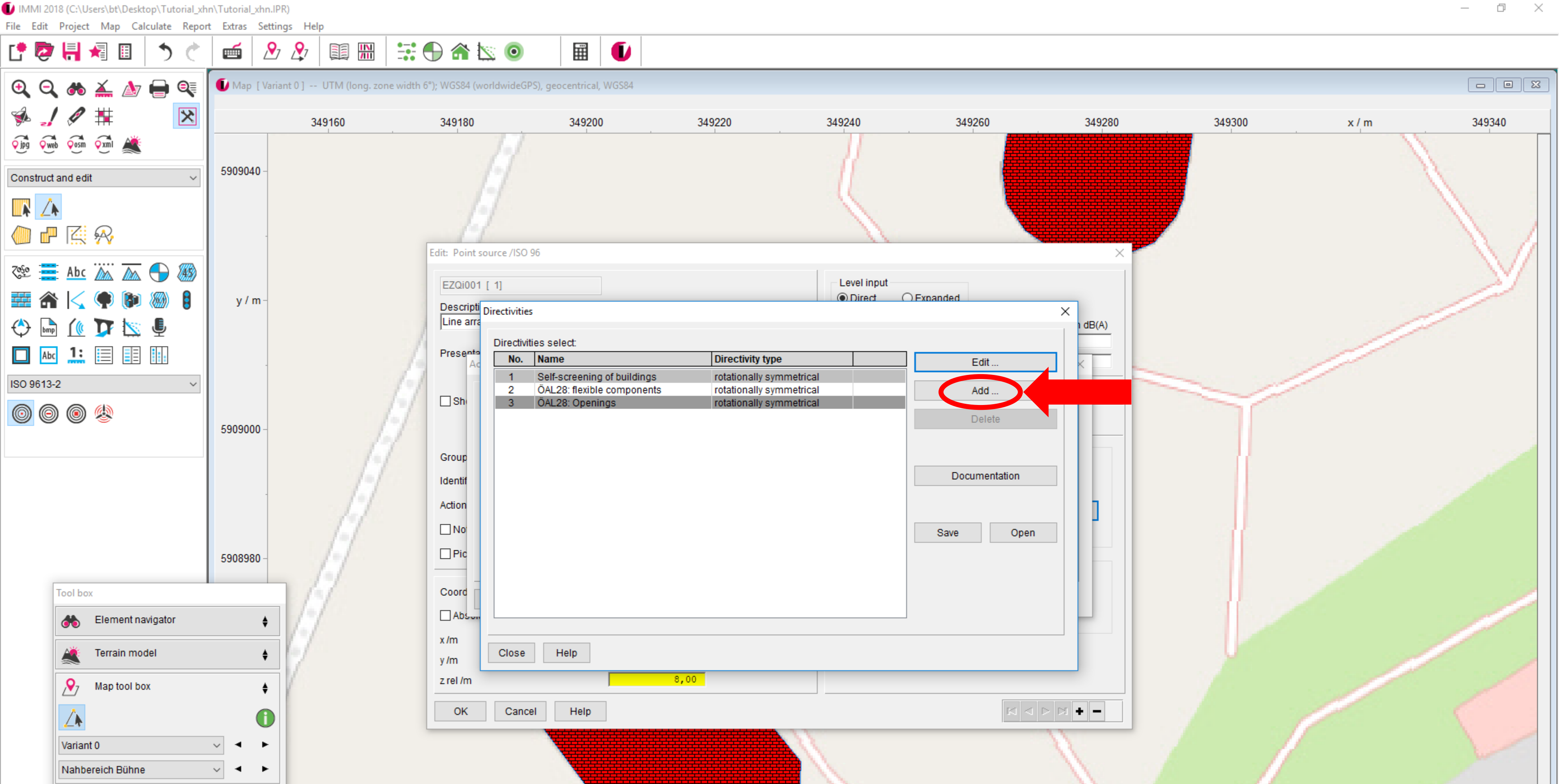

You'll find a list of the predefined settings and you can add your own by clicking the button „Add“.

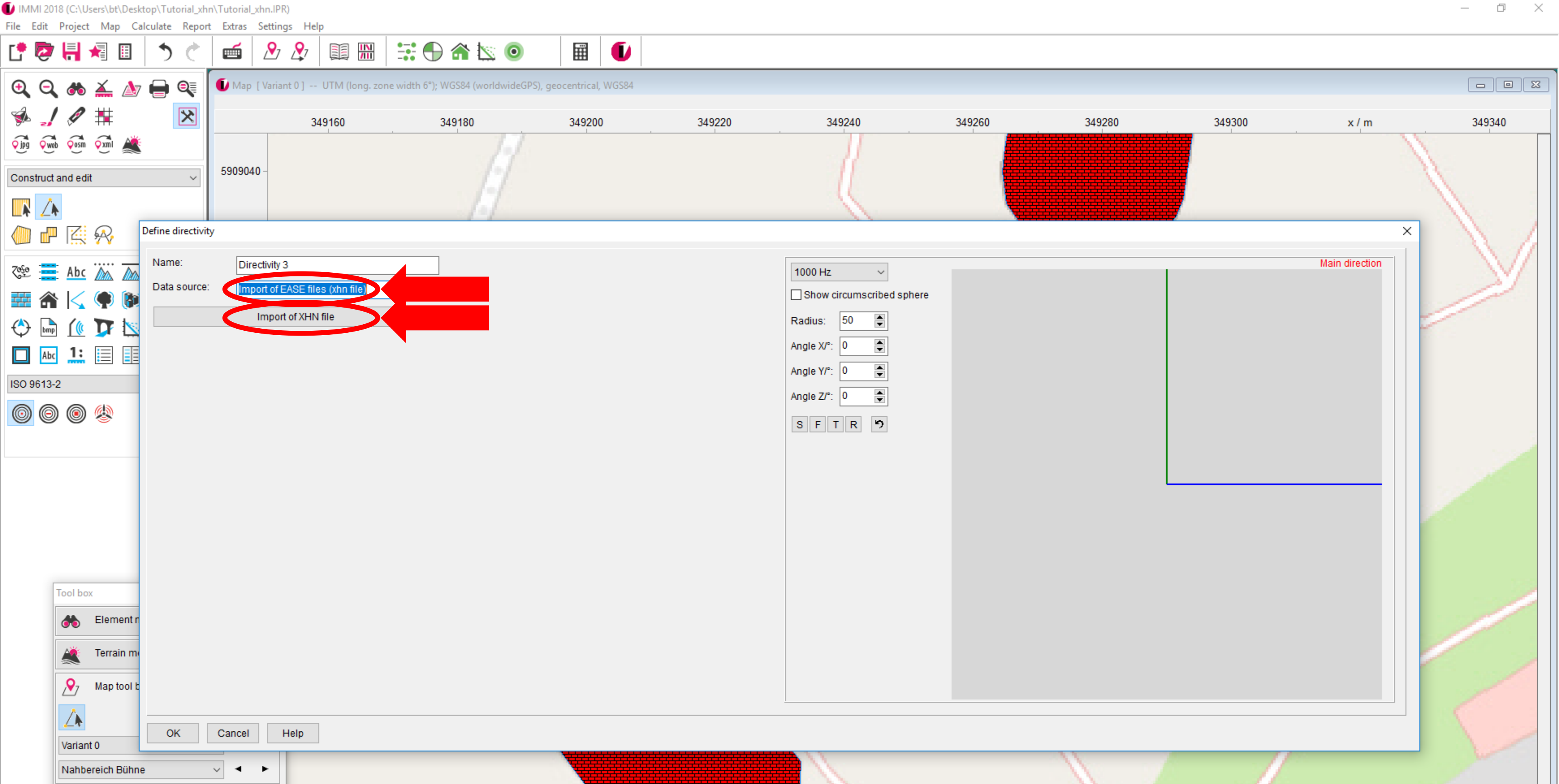

Choose „Import of EASE files (xhn file) and click the respective import button below.

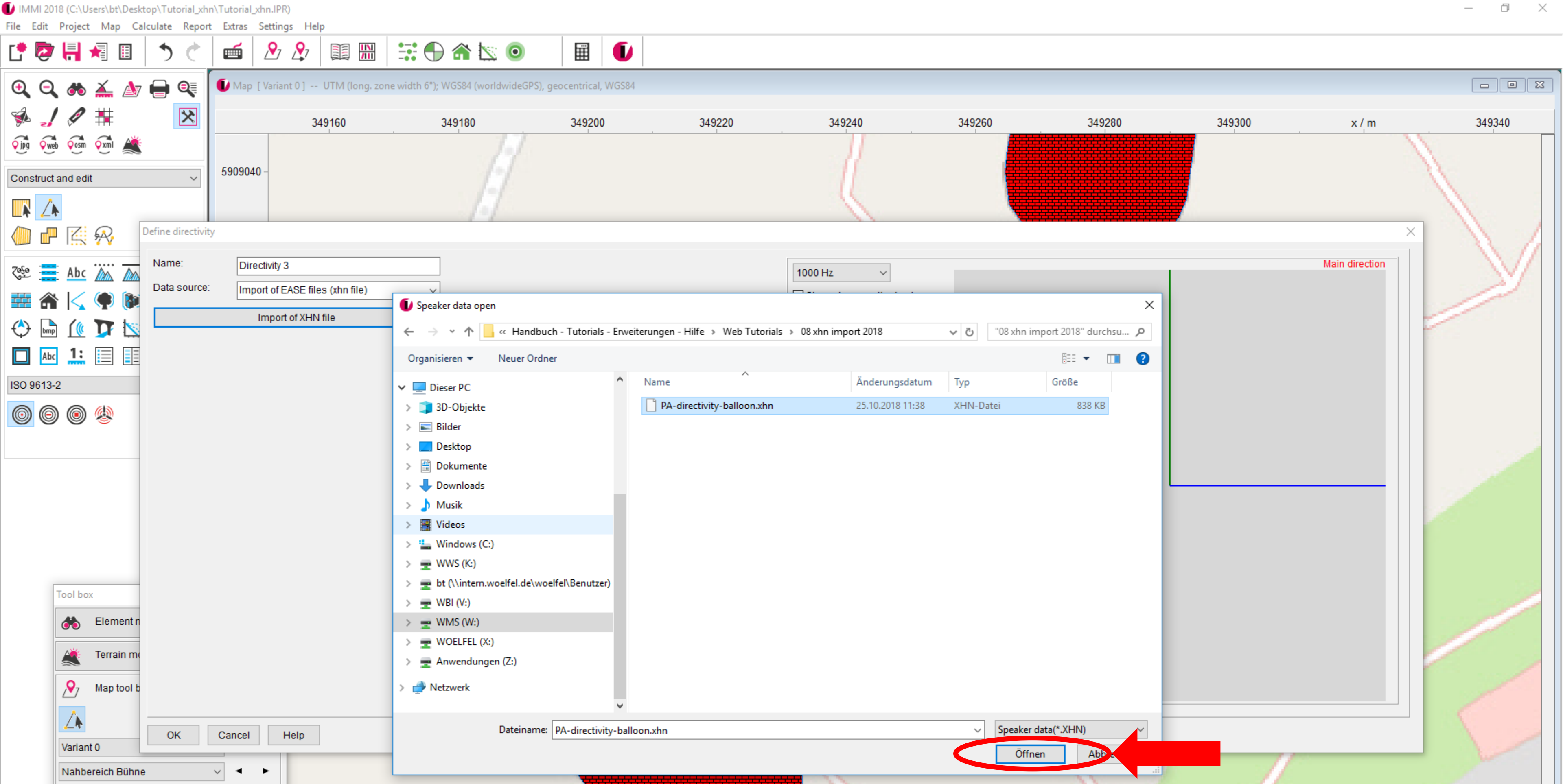

Choose the path of the xhn file and click „Open“.

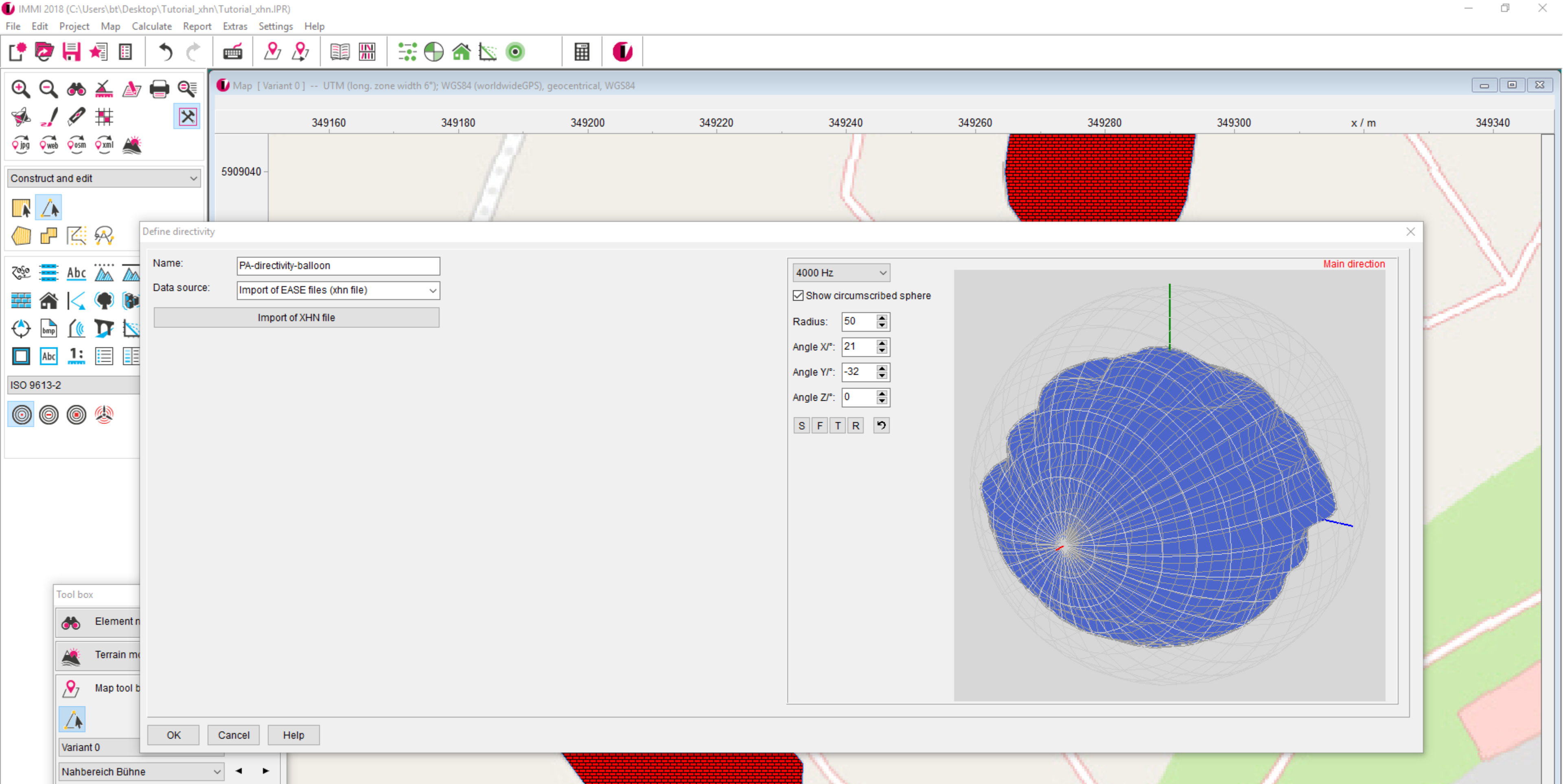

The balloon has been imported. You can now switch between the different frequencies and display different views.

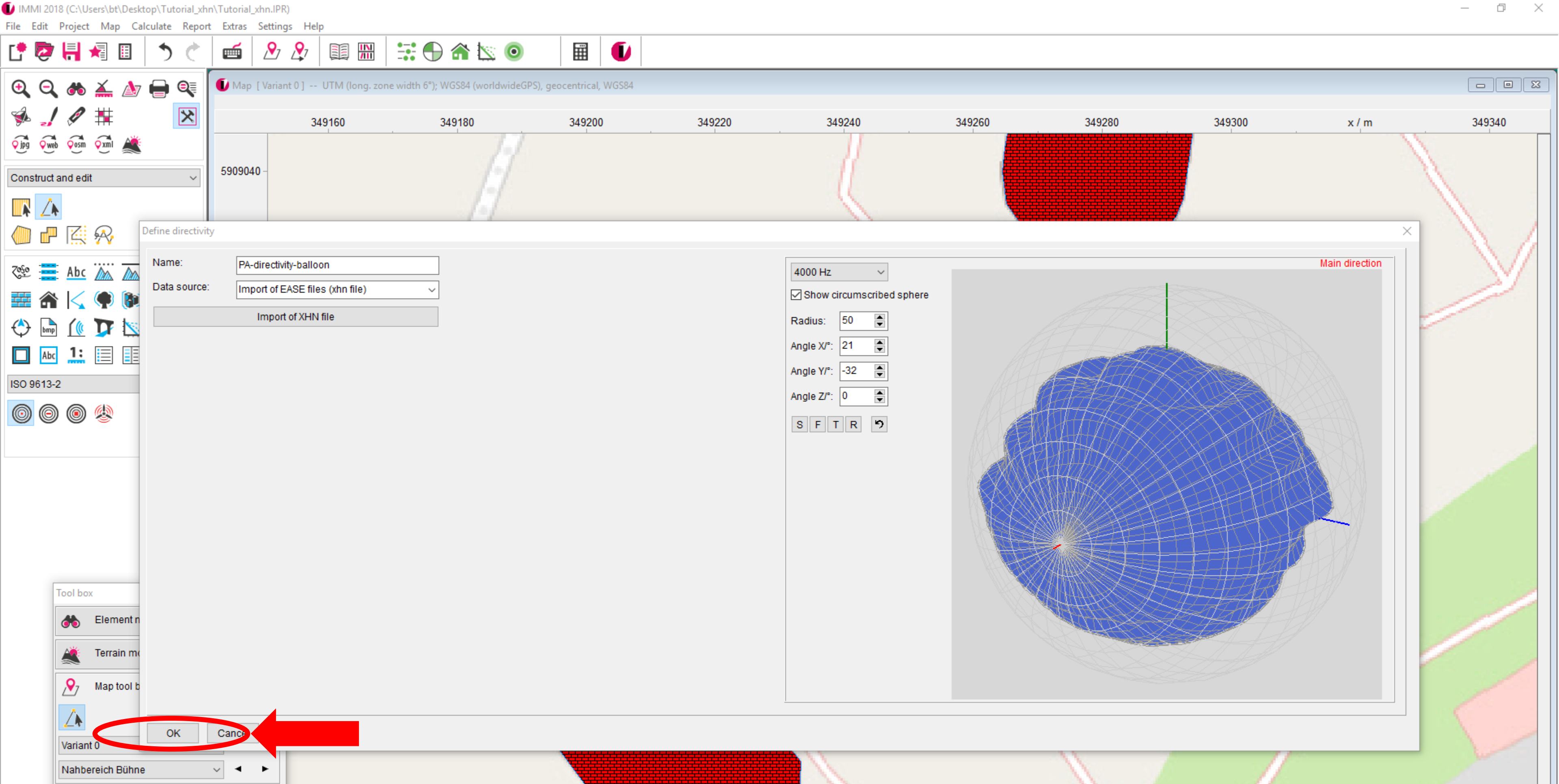

The angle of view can also be rotated by the use of the mouse (hold and move). Confirm with OK.

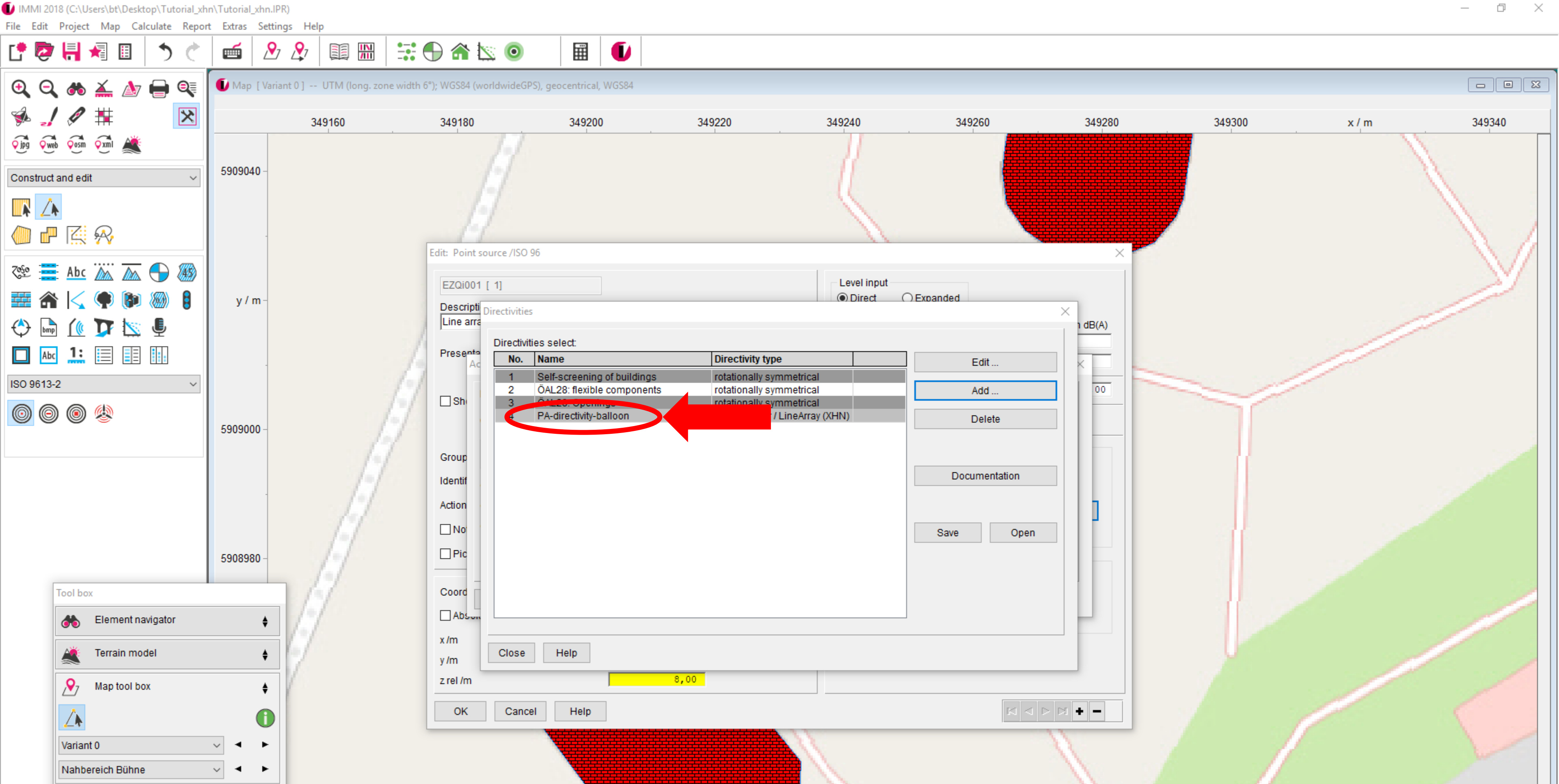

A new entry has been generated...

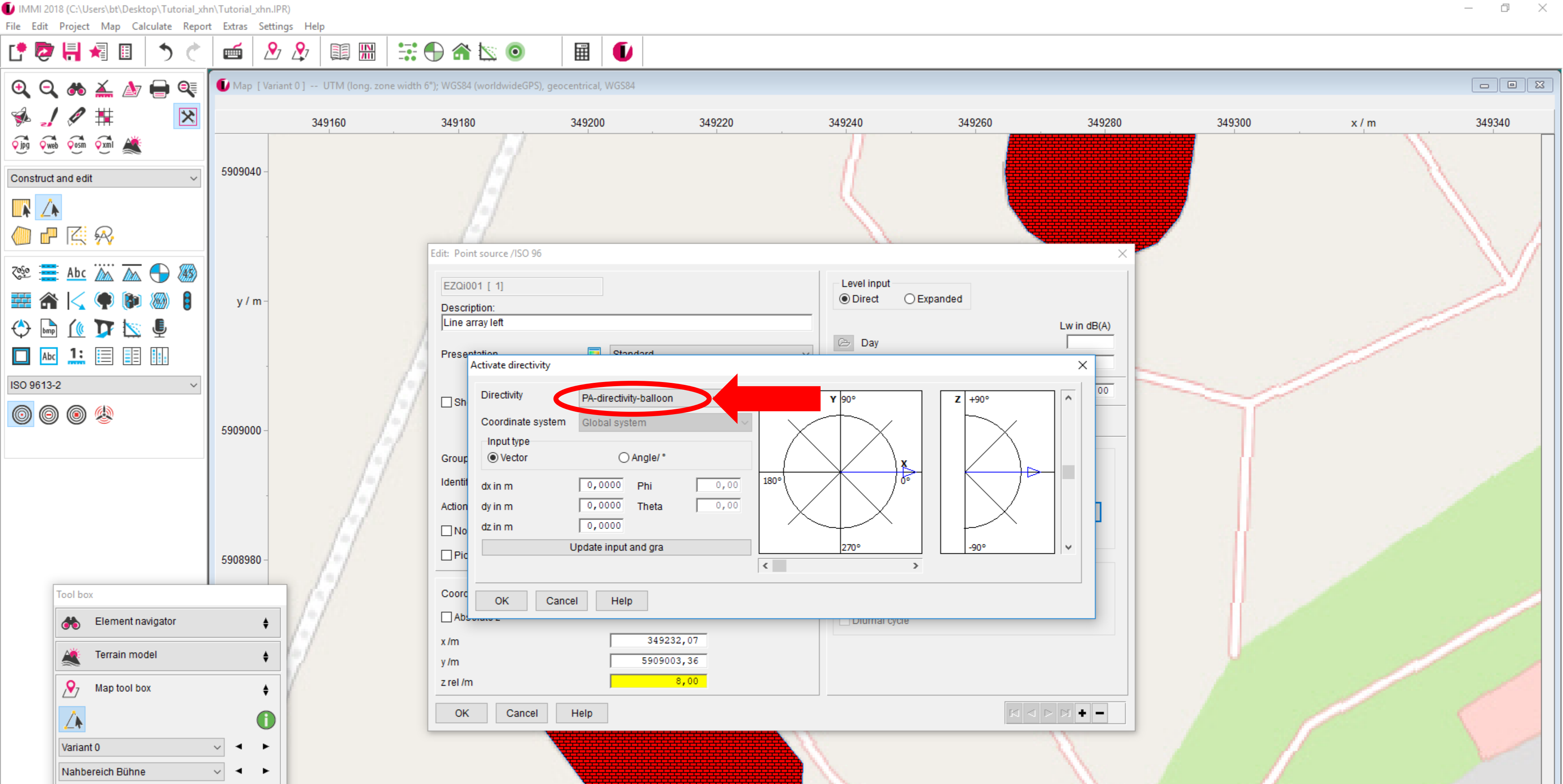

...which can now be chosen in the directivity menu.

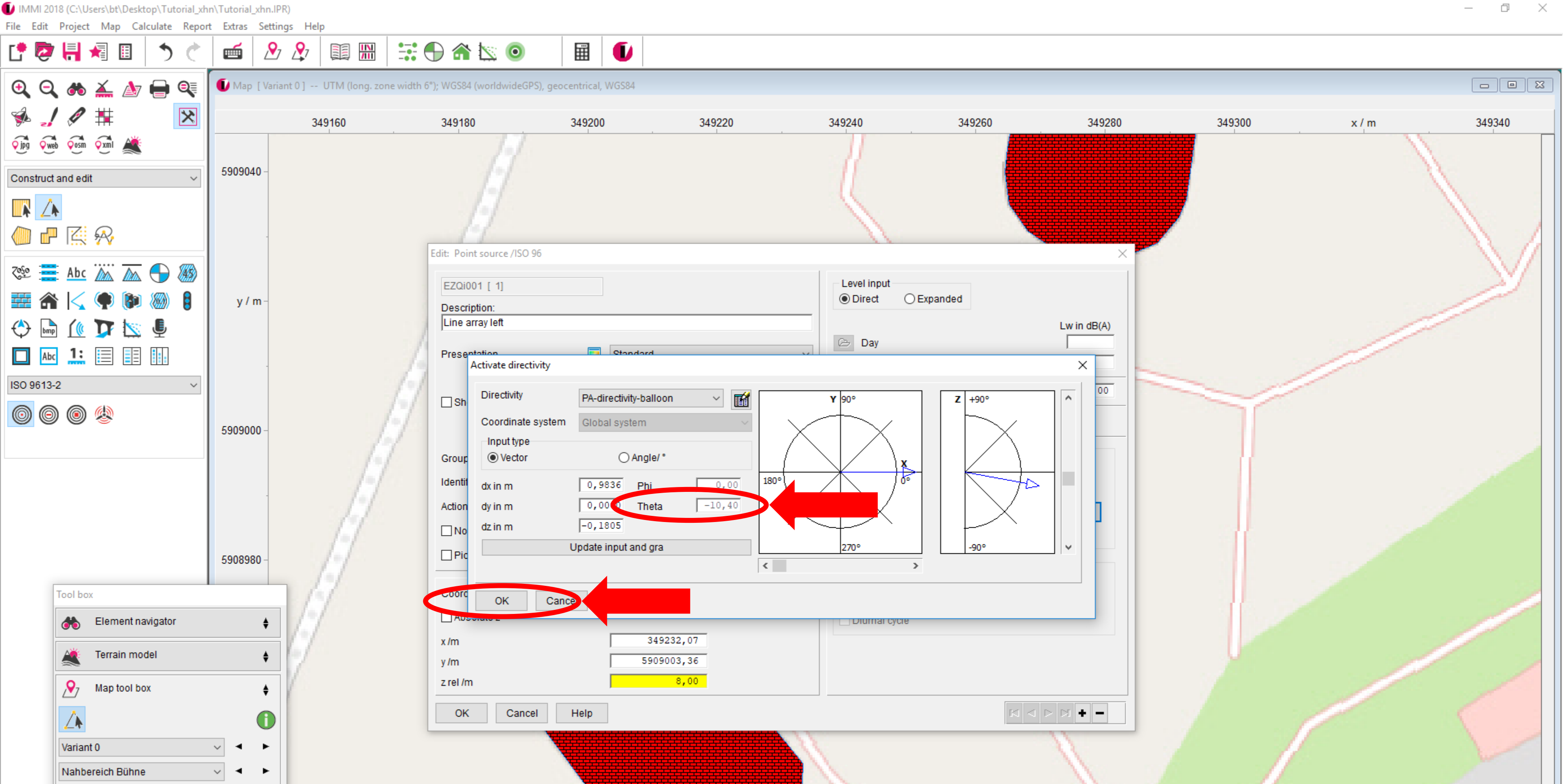

Enter the angle α in the text field for „Theta“ in order to define the slight downward orientation of the array. Confirm with OK.

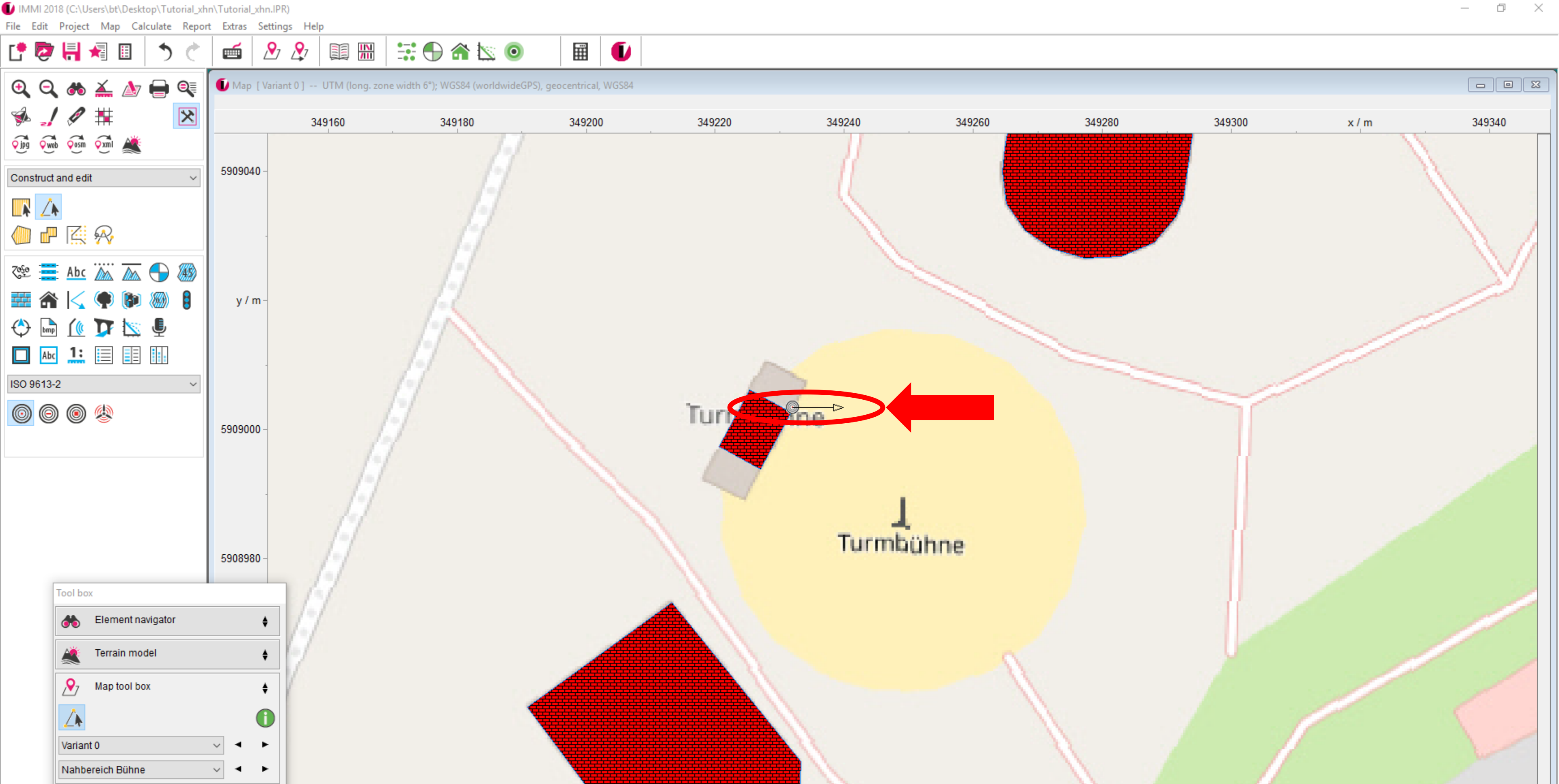

After closing the element dialogue with „OK“, the orientation of the directivity is displayed as a vector in the map.

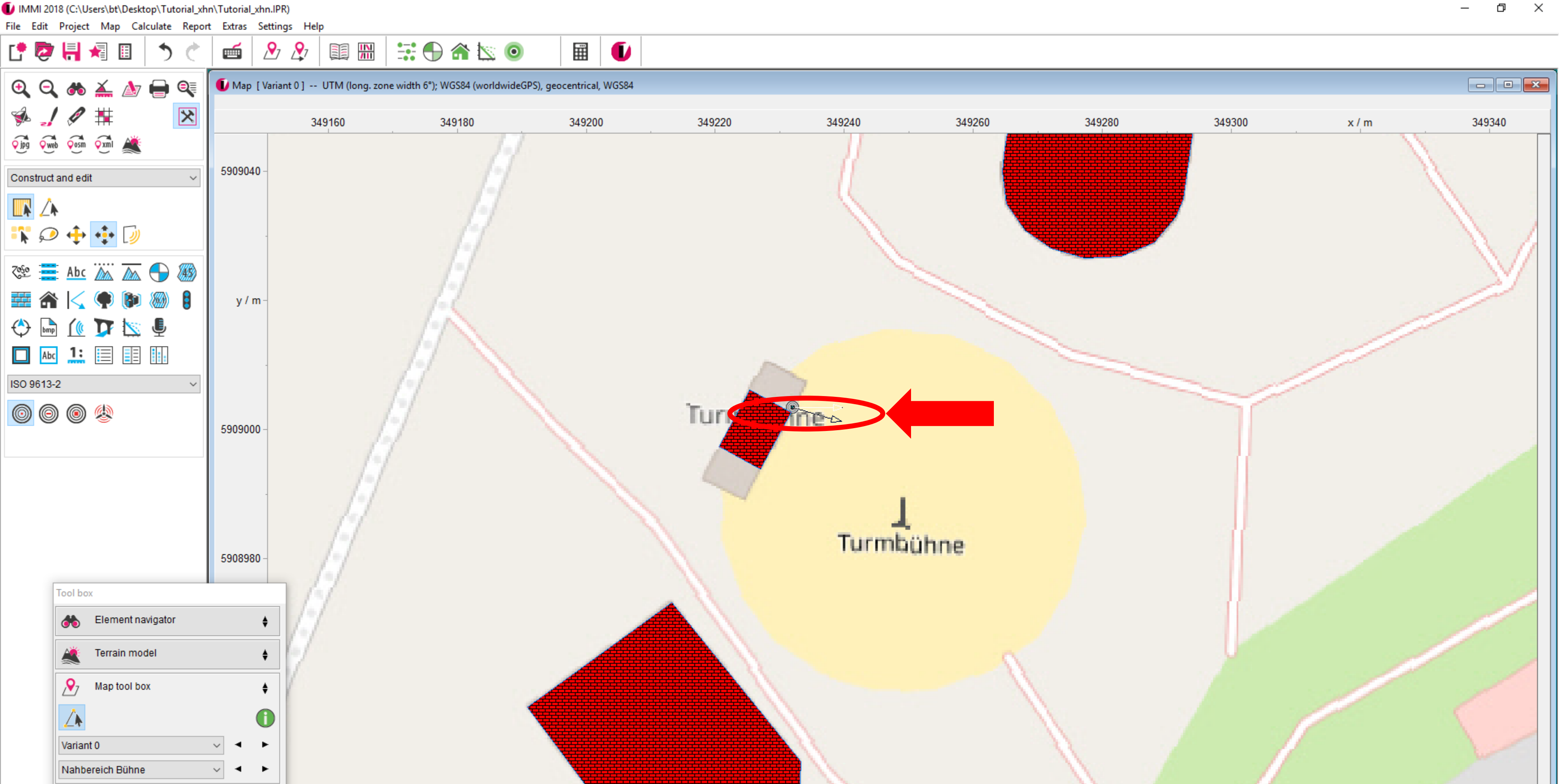

The directivity can be rotated by pressing the shift key, holding the left mouse button and moving the mouse.

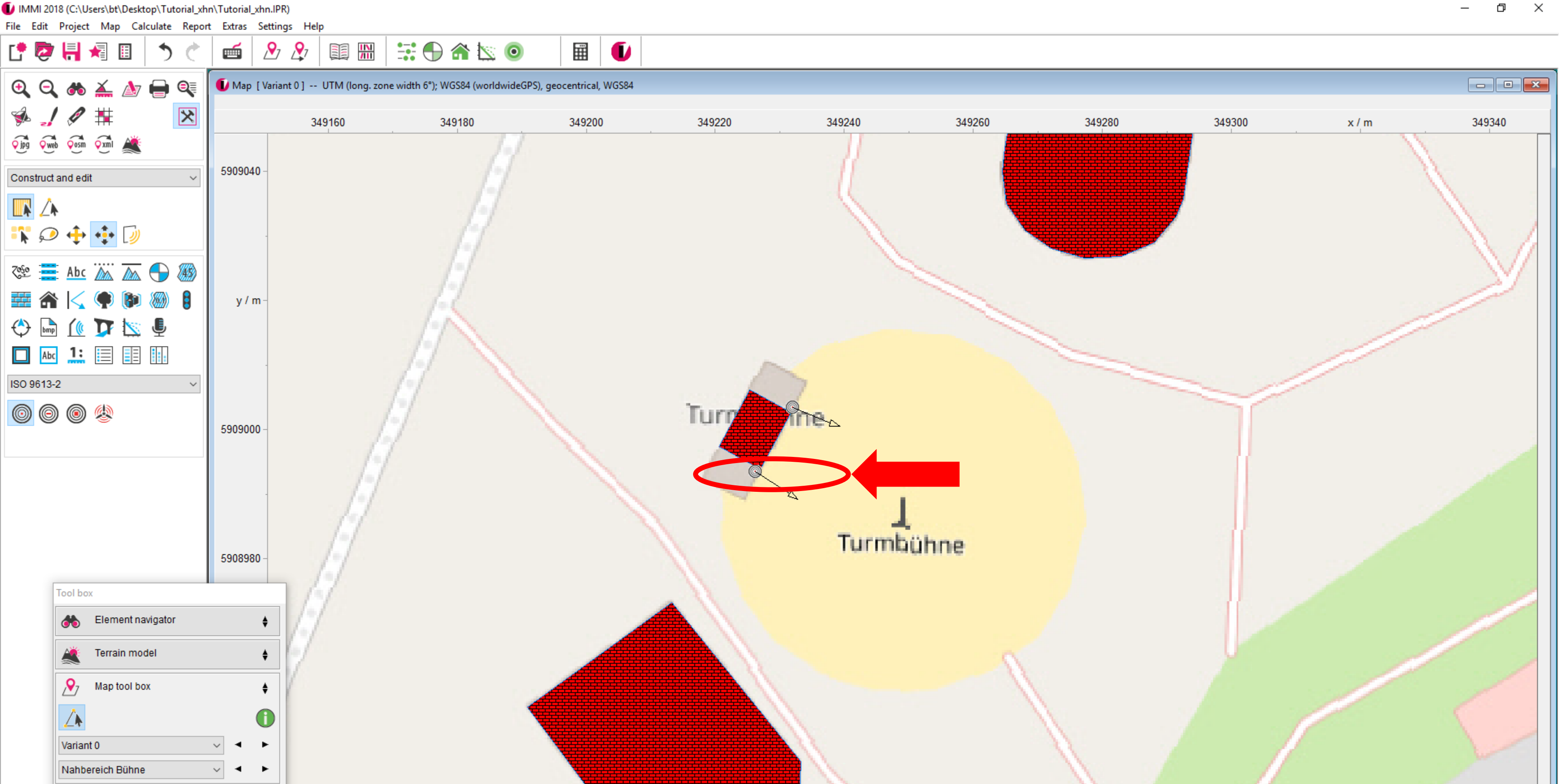

Please model the line array on the righthand side of the stage following the same procedure.

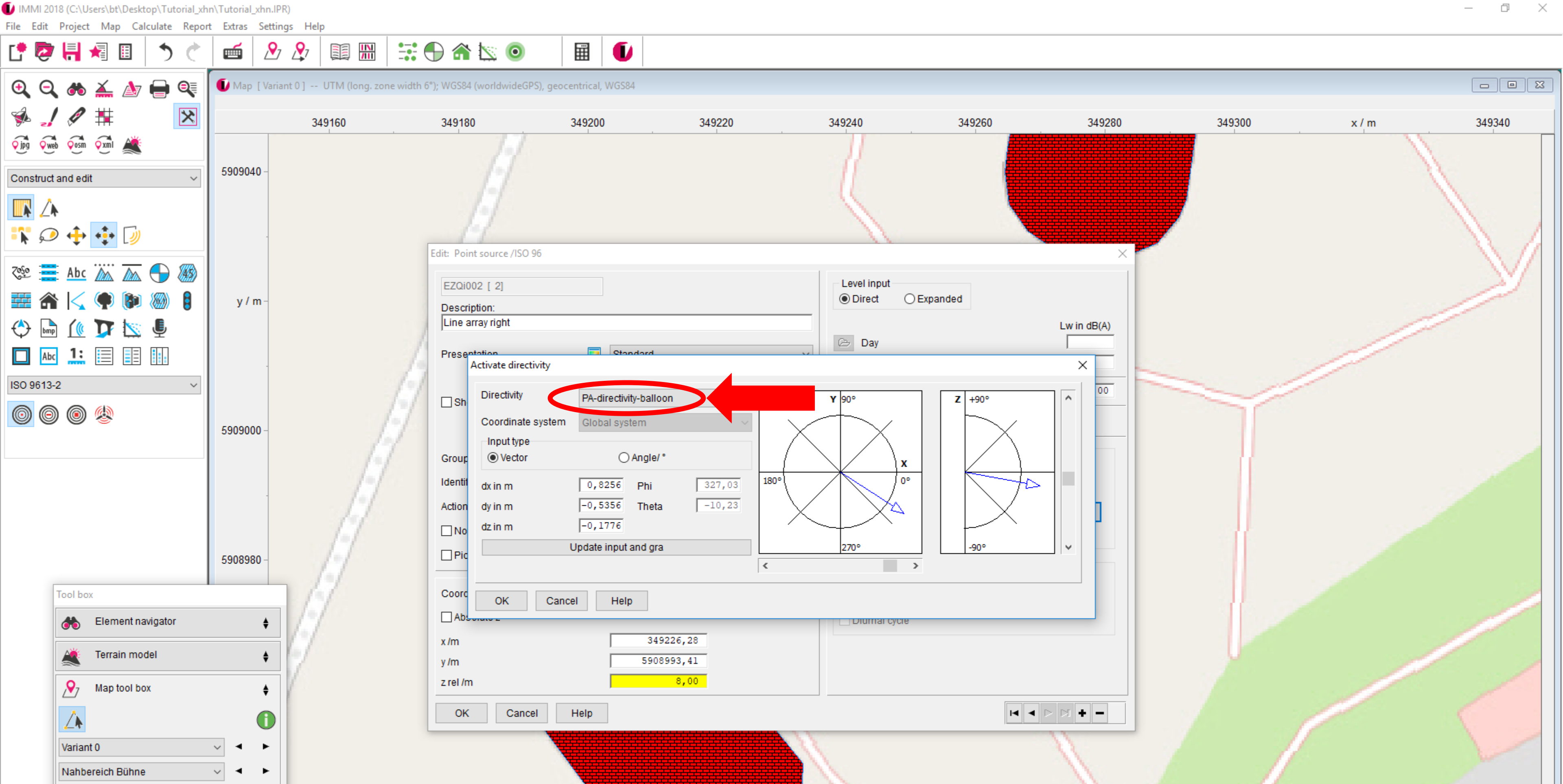

The imported directivity can now be chosen directly.

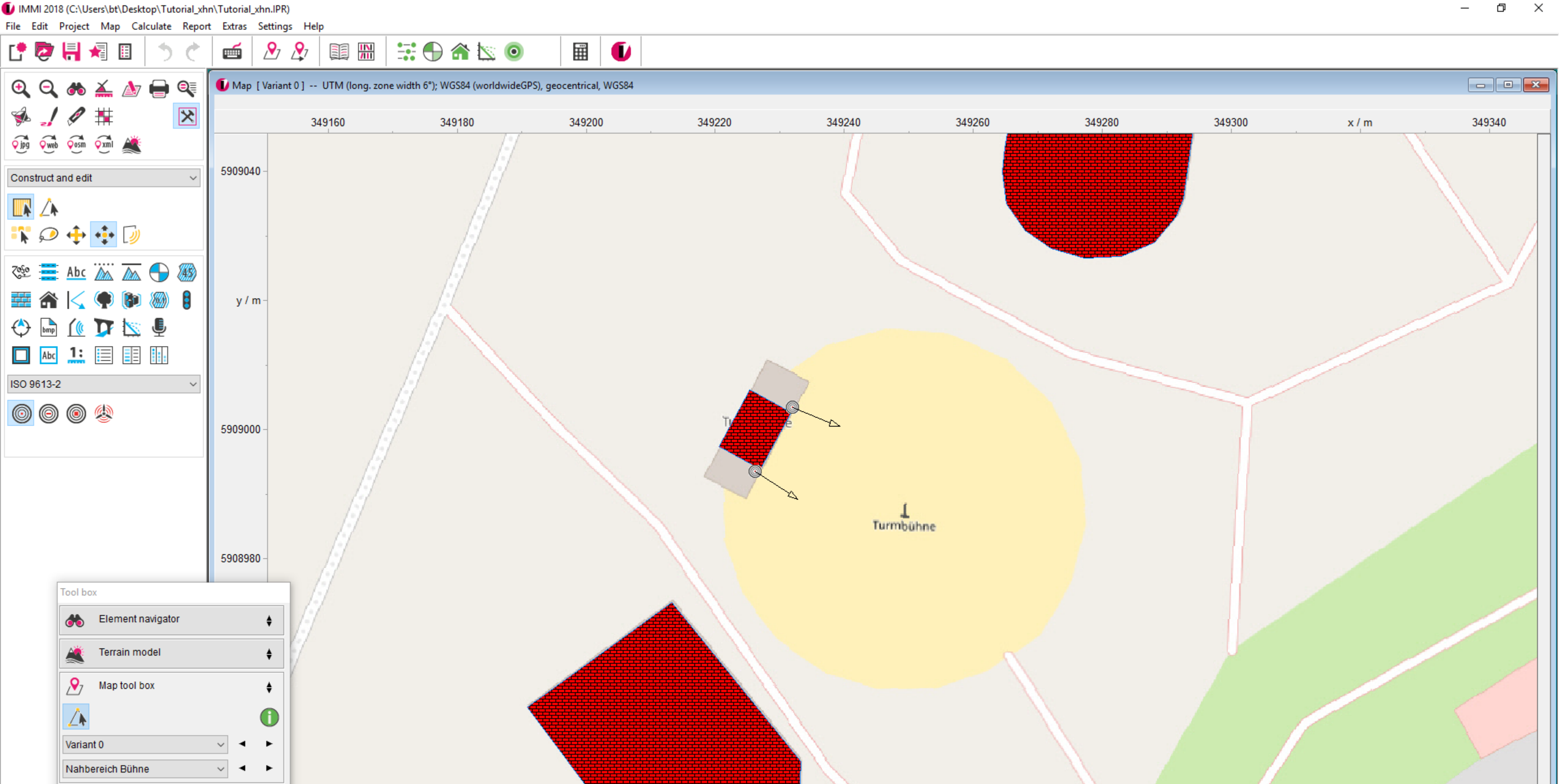

The next step is the assignment of the sound power levels. Therefore we use an IMMI element called measurement point.

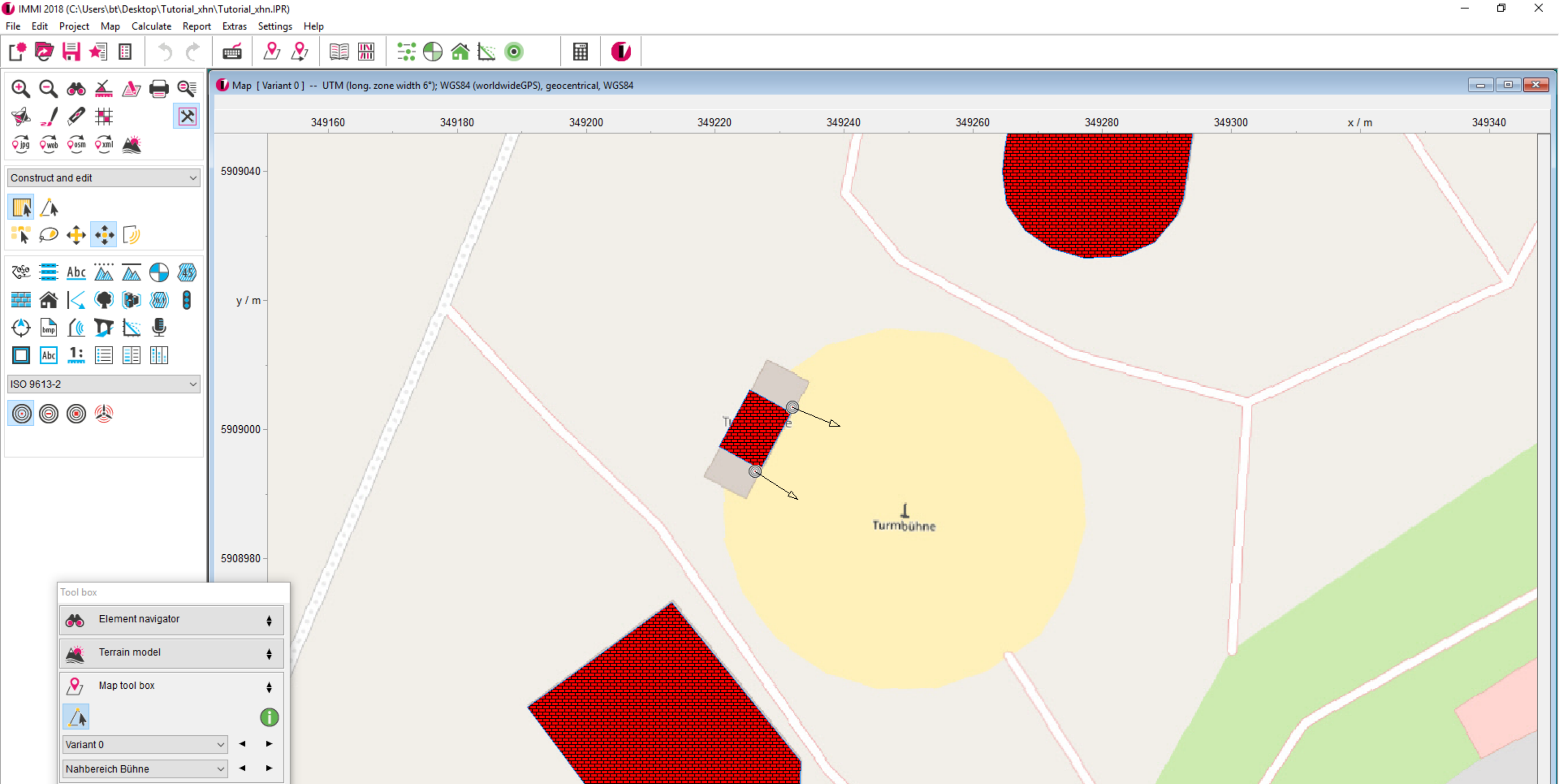

With this element we can calibrate the sound power level of the arrays to the desired value in the audience (FoH position).

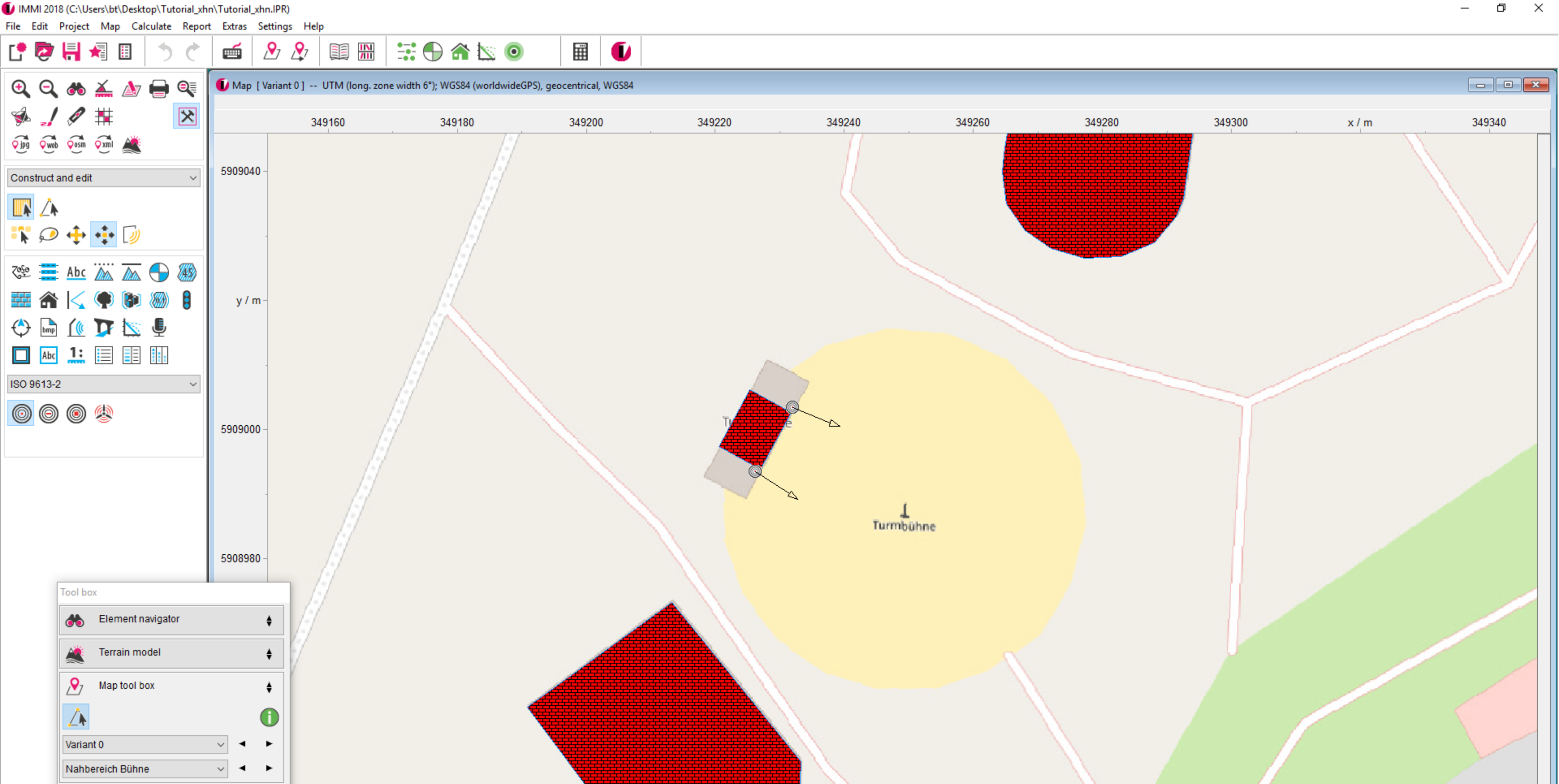

For a more detailed study you can use a near field directivity for the FoH calibration and a far field directivity for far field propagation.

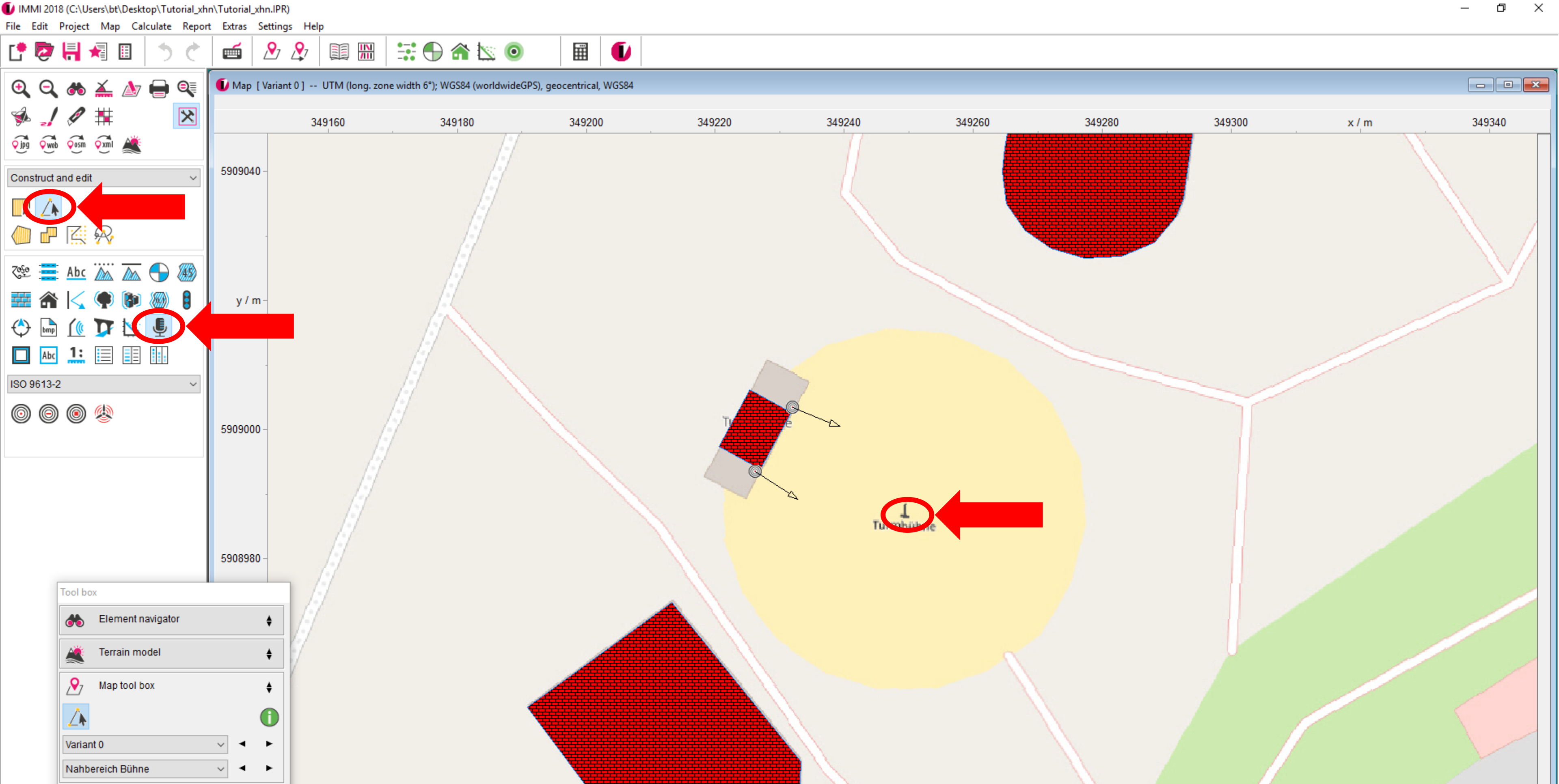

Please select the construction tool and the measurement point and model a measurement point at the center of the audience.

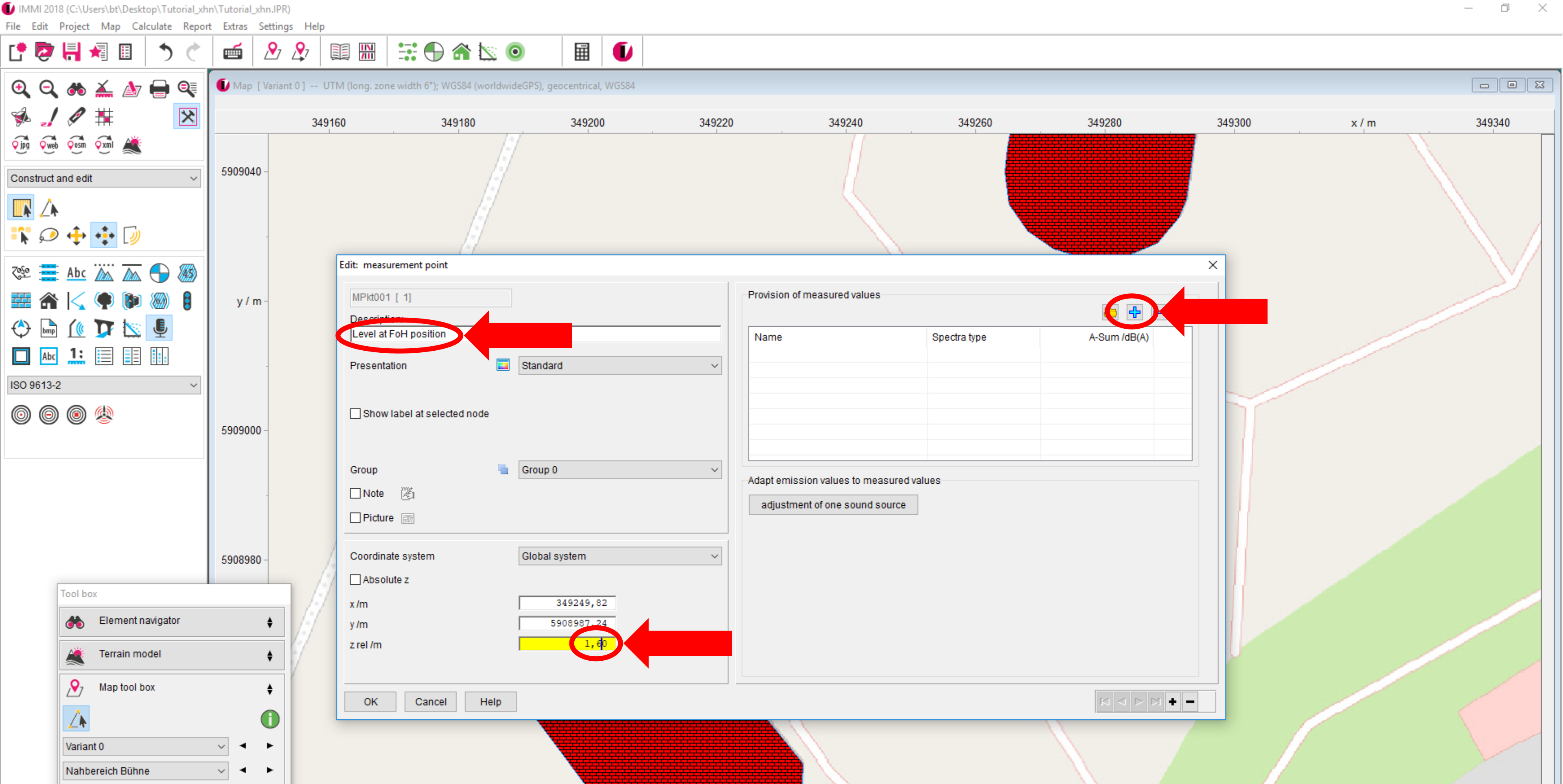

Enter a description and a relative height. Then press the „+“ button in order to define the level to which the line arrays shall be calibrated.

IMMI 2018 (C:\Users\bt\Desktop\Tutorial_xhn.IPR)

File Edit Project Map Calculate Report Extras Settings Help

Map [Variant 0] -- UTM (long. zone width 6°); WGS84 (worldwideGPS), geocentrical, WGS84

x / m: 349160 349180 349200 349220 349240 349260 349280 349300 349340

y / m: 5909040 5909000 5908980

Construct and edit

ISO 9613-2

Tool box

- Element navigator
- Terrain model
- Map tool box
- Variant 0
- Nahbereich Bühne

Edit: measurement point

MPkt001 [1]

Description: Level at FoH position

Presentation

Show label at selected node

Group

Note Picture

Coordinate system

Absolute z

x / m

y / m

z rel / m

Input of frequency-dependent measured values

Title of measurement: Calibration

Overall level /dB: A: LIN:

Spectrum type: **Third-octaves (linear)**

Lp/dB

Third band mid-frequency: 50 Hz

f /Hz	16	31.5	63	125	250	500	1000	2000	4000	8000
Lp/dB	-99,0	-99,0	-99,0	-99,0	-99,0	-99,0	-99,0	-99,0	-99,0	-99,0
Lp/dB	-99,0	-99,0	-99,0	-99,0	-99,0	-99,0	-99,0	-99,0	-99,0	-99,0
Lp/dB	-99,0	-99,0	-99,0	-99,0	-99,0	-99,0	-99,0	-99,0	-99,0	-99,0

Note

OK Cancel Help

A-Sum /dB(A)

Change the spectrum type to „third-octaves (linear)“ and rightclick into the empty area of the diagram.

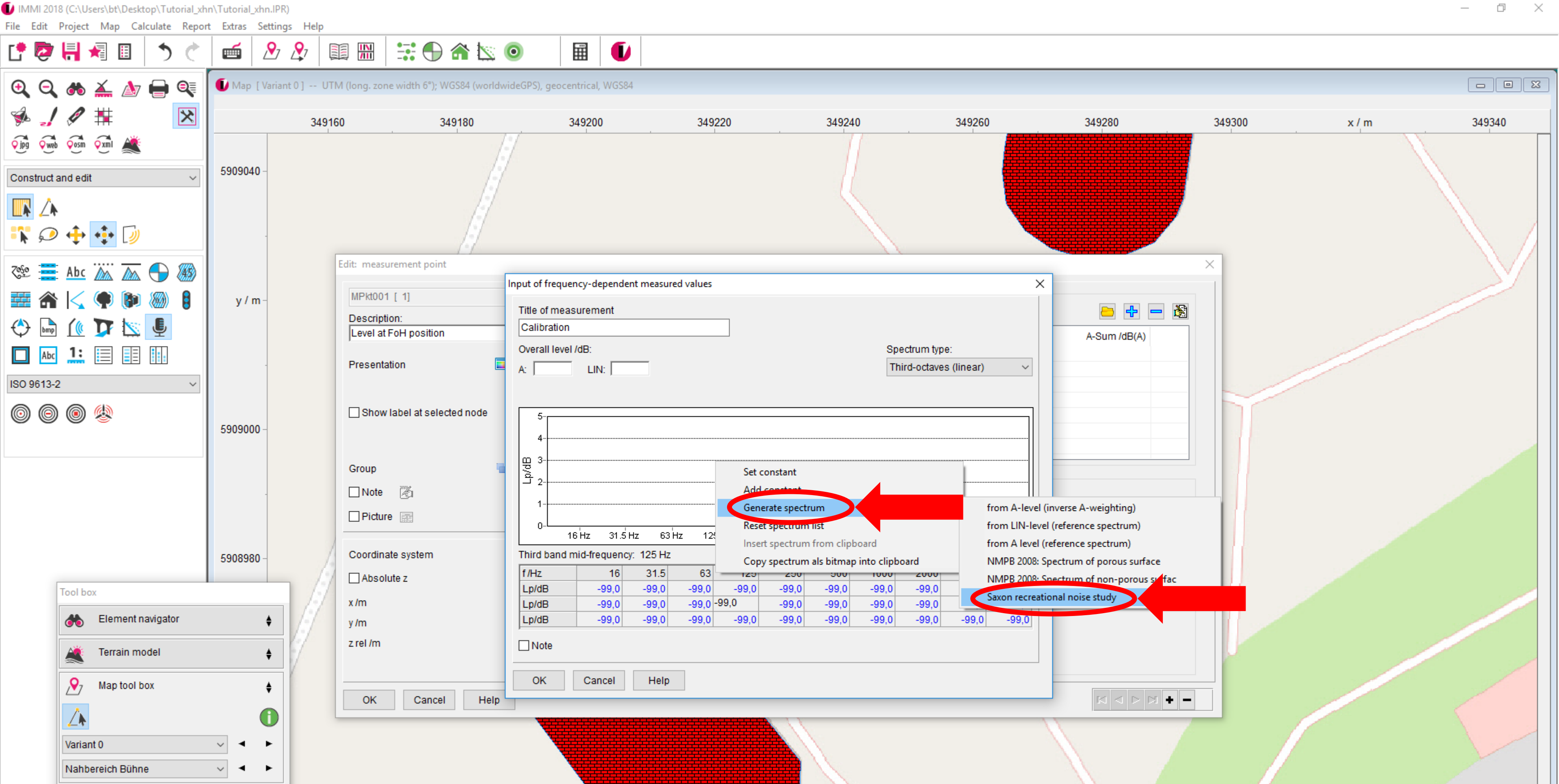

Go to <Generate spectrum/Saxon recreational noise study> in order to create a suitable spectrum.

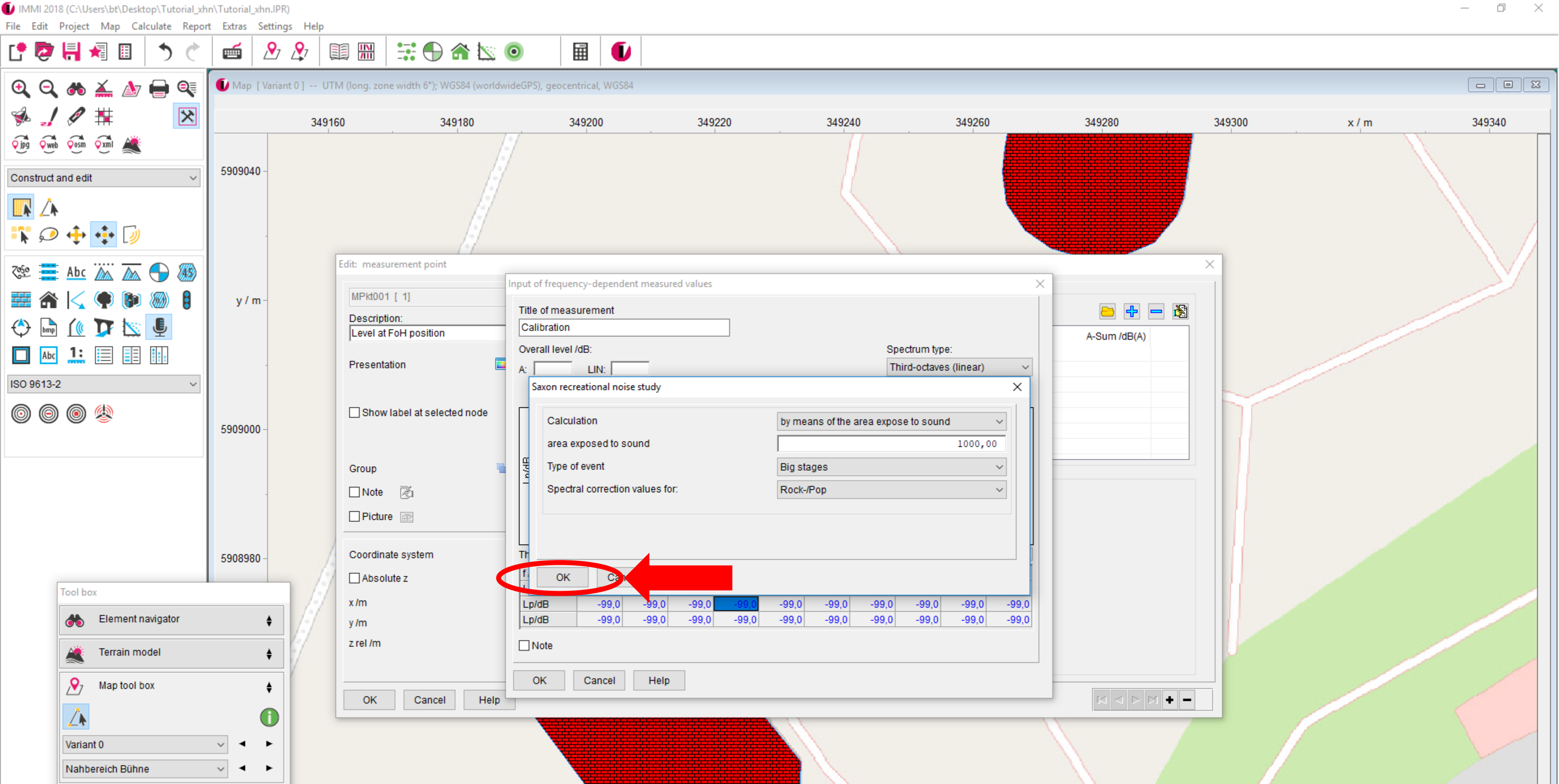

Confirm the default settings with OK.

IMMI 2018 (C:\Users\bt\Desktop\Tutorial_xhn\Tutorial_xhn.IPR)

File Edit Project Map Calculate Report Extras Settings Help

Map [Variant 0] -- UTM (long. zone width 6°); WGS84 (worldwideGPS), geocentric, WGS84

349160 349180 349200 349220 349240 349260 349280 349300 x / m

5909040 y / m

5909000

5908980

Construct and edit

ISO 9613-2

Tool box

- Element navigator
- Terrain model
- Map tool box
- Variant 0
- Nahbereich Bühne

Edit: measurement point

MPkt001 [1]

Description:
Level at FoH position

Presentation

Show label at selected node

Group

Note Picture

Coordinate system

Absolute z

x / m

y / m

z rel / m

Input of frequency-dependent measured values

Title of measurement
Calibration

Overall level /dB:
A: 129,1 LIN: 135,8

Spectrum type:
Third-octaves (linear)

Third band mid-frequency: 125 Hz

f /Hz	16	31.5	63	125	250	500	1000	2000	4000	8000
Lp/dB	-99,0	-99,0	125,1	126,3	120,5	121,7	121,6	117,6	112,7	105,4
Lp/dB	-99,0	102,0	128,5	121,3	121,1	121,7	119,8	115,5	110,6	103,5
Lp/dB	-99,0	118,4	128,7	119,5	122,3	122,0	118,8	114,2	107,2	101,0

A-Sum /dB(A)

OK Cancel Help

We now obtained a spectrum with an overall level of 129 dB. In order to adjust it to the desired value, rightclick into the diagram.

IMMI 2018 (C:\Users\bt\Desktop\Tutorial_xhn\Tutorial_xhn.IPR)

File Edit Project Map Calculate Report Extras Settings Help

Map [Variant 0] -- UTM (long. zone width 6°); WGS84 (worldwideGPS), geocentric, WGS84

x / m: 349160 349180 349200 349220 349240 349260 349280 349300 349340

y / m: 5909040 5909000 5908980

Construct and edit

ISO 9613-2

Tool box

- Element navigator
- Terrain model
- Map tool box
- Variant 0
- Nahbereich Bühne

Edit: measurement point

MPkt001 [1]

Description: Level at FoH position

Presentation

Show label at selected node

Group

Note Picture

Coordinate system

Absolute z

x / m

y / m

z rel / m

Input of frequency-dependent measured values

Title of measurement: Calibration

Overall level /dB: A: 129,1 LIN: 135,8

Spectrum type: Third-octaves (linear)

Lp/dB

16 Hz 31.5 Hz 63 Hz 125 Hz 250 Hz 500 Hz 1000 Hz 2000 Hz 4000 Hz 8000 Hz

Third band mid-frequency: 160 Hz

f /Hz	16	31.5	63	125	250	500	1000	2000	4000	8000
Lp/dB	-99,0	-99,0	125,1	126,3	120,5	121,7	121,6	117,6	112,7	105,4
Lp/dB	-99,0	102,0	128,5	121,3	121,1	121,7	119,8	115,5	110,6	103,5
Lp/dB	-99,0	118,4	128,7	119,5	122,3	122,0	118,8	114,2	107,2	101,0

Note

OK Cancel Help

A-Sum /dB(A)

Choose <Add constant> and enter a value of - 32,1. Confirm with OK.

IMMI 2018 (C:\Users\bt\Desktop\Tutorial_xhn\Tutorial_xhn.IPR)

File Edit Project Map Calculate Report Extras Settings Help

Map [Variant 0] -- UTM (long. zone width 6°); WGS84 (worldwideGPS), geocentric, WGS84

349160 349180 349200 349220 349240 349260 349280 349300 x / m

5909040 y / m

5909000

5908980

Construct and edit

ISO 9613-2

Tool box

- Element navigator
- Terrain model
- Map tool box
- Variant 0
- Nahbereich Bühne

Edit: measurement point

MPkt001 [1]

Description:
Level at FoH position

Presentation

Show label at selected node

Group

Note Picture

Coordinate system

Absolute z

x / m

y / m

z rel / m

Input of frequency-dependent measured values

Title of measurement
Calibration

Overall level /dB:
A: 97,0 LIN: 103,7

Spectrum type:
Third-octaves (linear)

Third band mid-frequency: 100 Hz

f /Hz	16	31.5	63	125	250	500	1000	2000	4000	8000
Lp/dB	-99,0	-99,0	93,0	94,2	88,4	89,6	89,5	85,5	80,6	73,3
Lp/dB	-99,0	69,9	96,4	89,2	89,0	89,6	87,7	83,4	78,5	71,4
Lp/dB	-99,0	86,3	96,6	87,4	90,2	89,9	86,7	82,1	75,1	68,9

A-Sum /dB(A)

OK Cancel Help

We now obtain our spectrum with an overall level of 97 dB(A).

IMMI 2018 (C:\Users\bt\Desktop\Tutorial_xhn\Tutorial_xhn.IPR)

File Edit Project Map Calculate Report Extras Settings Help

Map [Variant 0] -- UTM (long. zone width 6°); WGS84 (worldwideGPS), geocentric, WGS84

349160 349180 349200 349220 349240 349260 349280 349300 x / m

5909040 y / m

5909000

5908980

Construct and edit

ISO 9613-2

Tool box

- Element navigator
- Terrain model
- Map tool box
- Variant 0
- Nahbereich Bühne

Edit: measurement point

MPkt001 [1]

Description:
Level at FoH position

Presentation

Show label at selected node

Group

Note Picture

Coordinate system

Absolute z

x / m

y / m

z rel / m

Input of frequency-dependent measured values

Title of measurement
Calibration

Overall level /dB:
A: 97,0 LIN: 103,7

Spectrum type:
Third-octaves (linear)

Third band mid-frequency: 100 Hz

f /Hz	16	31.5	63	125	250	500	1000	2000	4000	8000
Lp/dB	-99,0	-99,0	93,0	94,2	88,4	89,6	89,5	85,5	80,6	73,3
Lp/dB	-99,0	69,9	96,4	89,2	89,0	89,6	87,7	83,4	78,5	71,4
Lp/dB	-99,0	86,3	96,6	87,4	90,2	89,9	86,7	82,1	75,1	68,9

A-Sum /dB(A)

OK Cancel Help

This value results from the fact that we want to achieve an overall level of 100 dB(A) at FoH position with both arrays contributing.

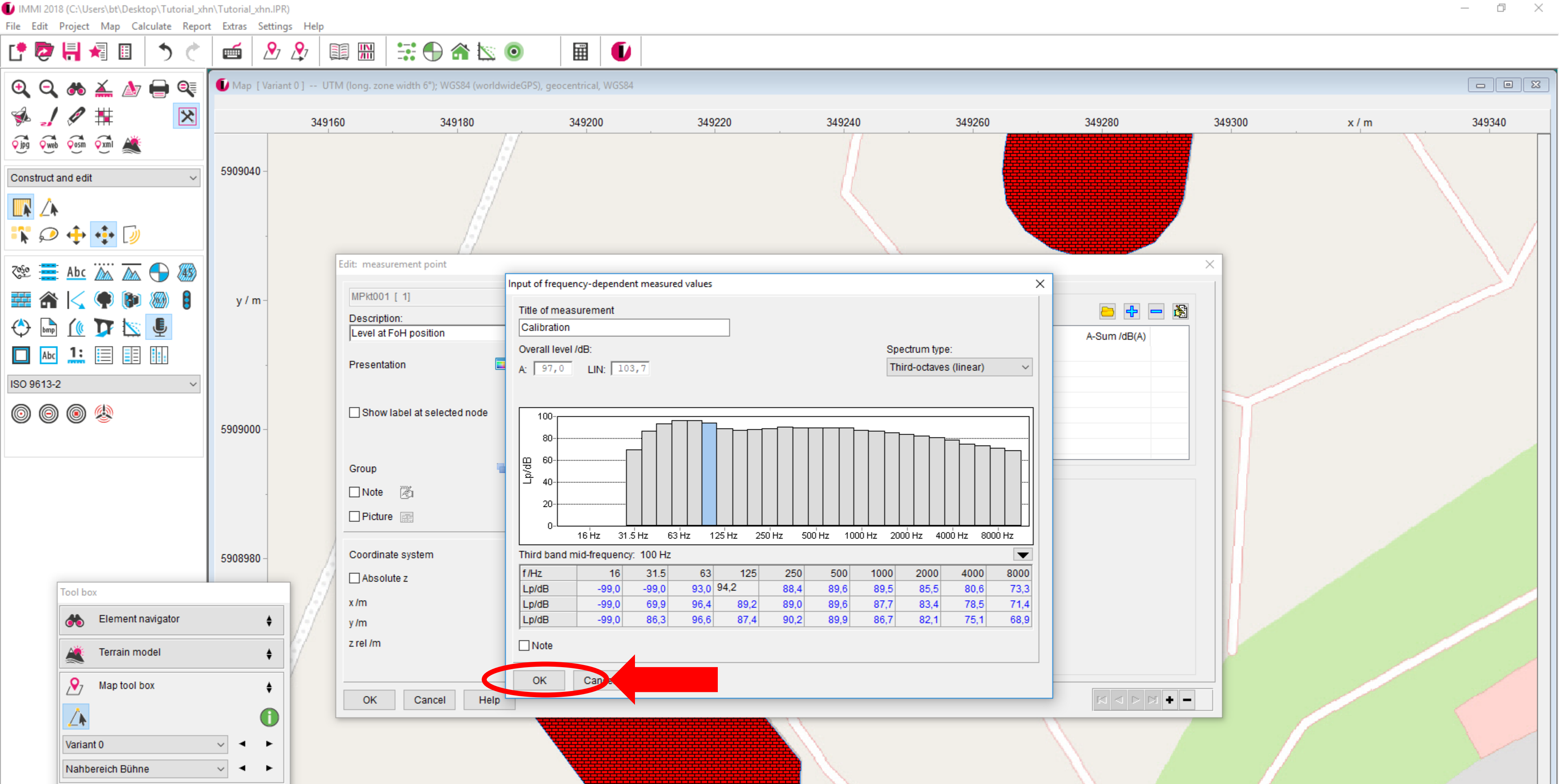

Close the dialogue with „OK“.

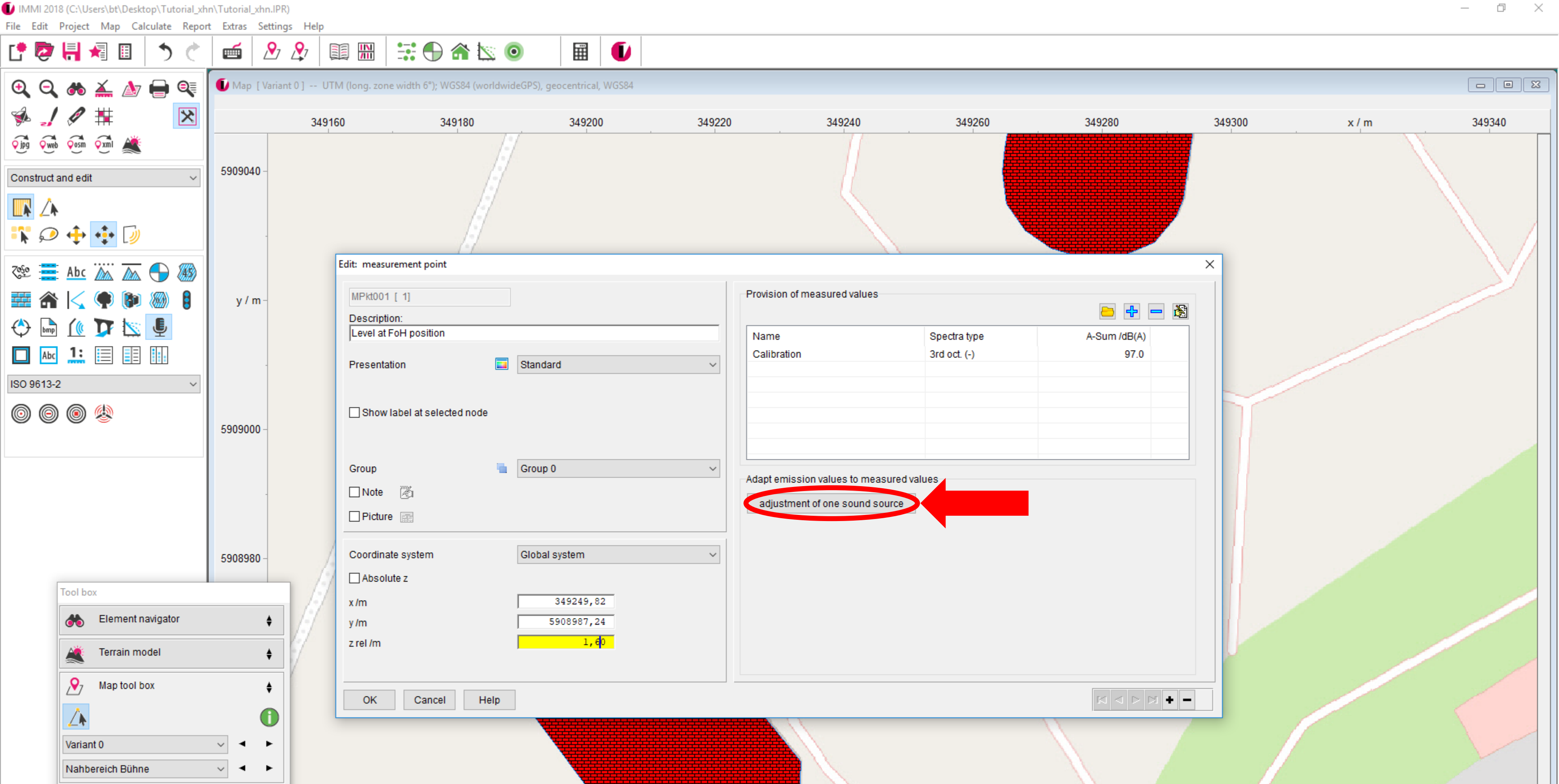

Now we will adjust one of the arrays with the button „adjustment of one sound source“.

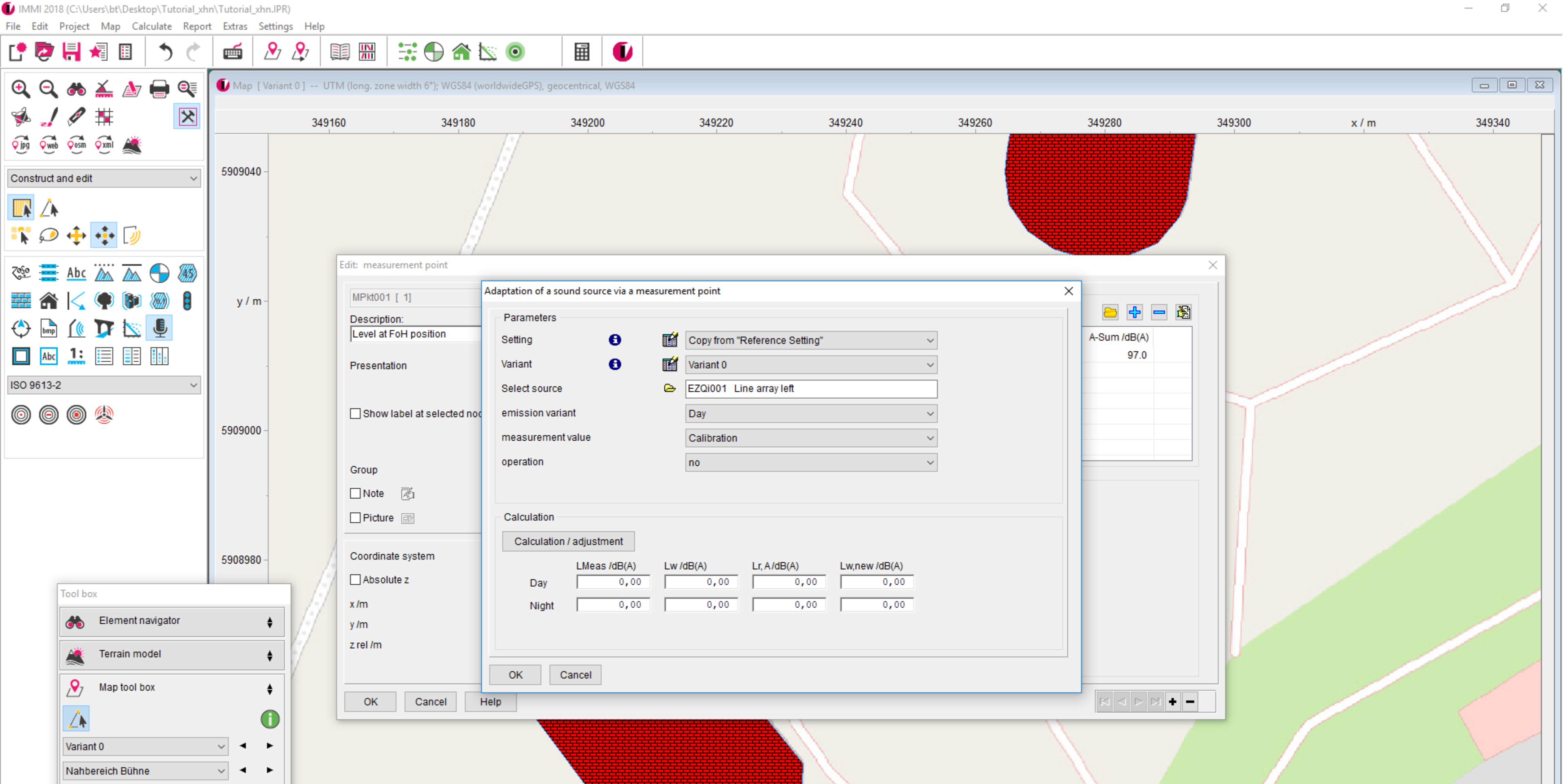

The dialogue allows to select the source to be calibrated and the parameters for the calibration.

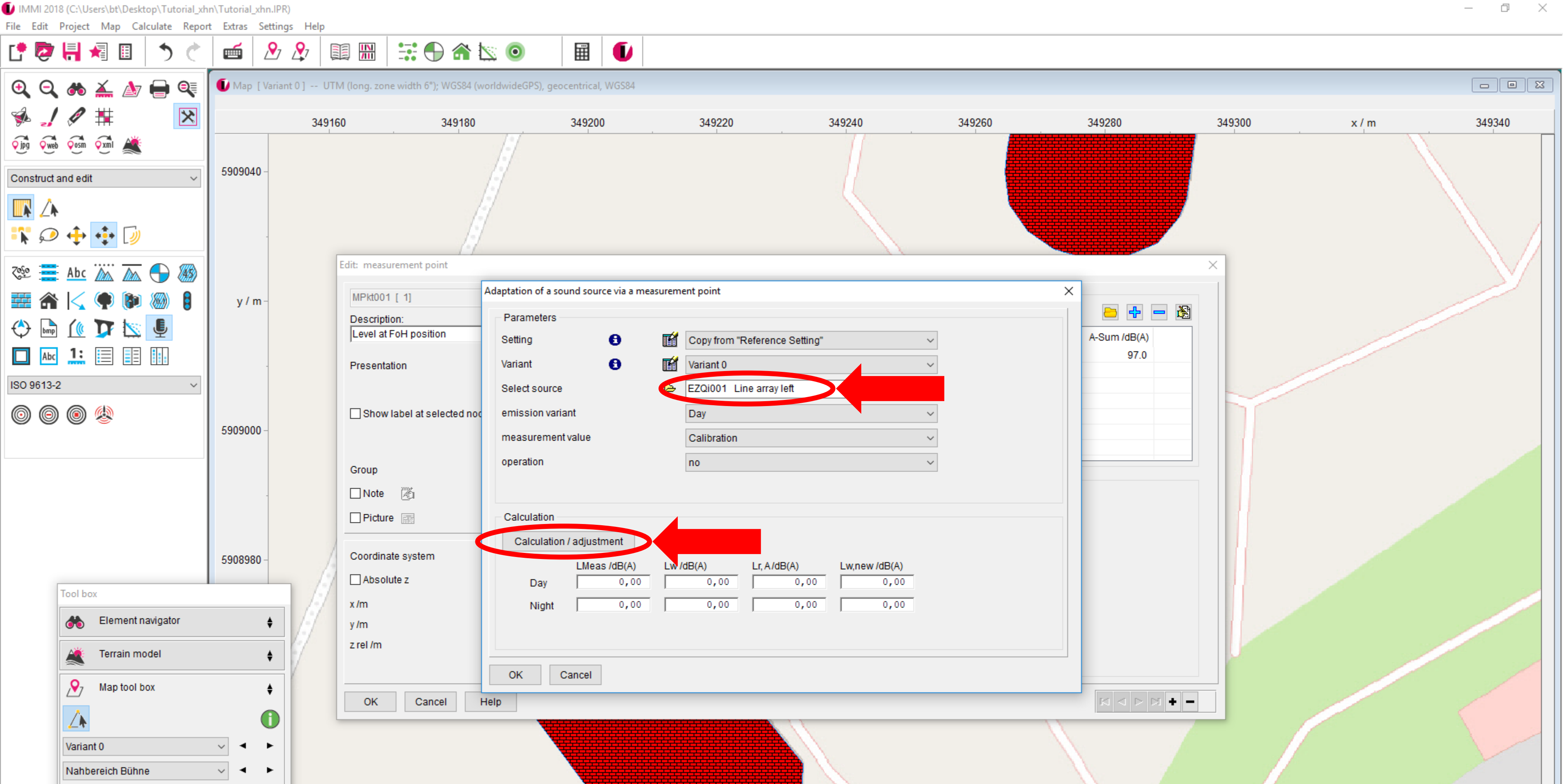

Make sure that „Line array left“ is selected and click „Calculation/adjustment“.

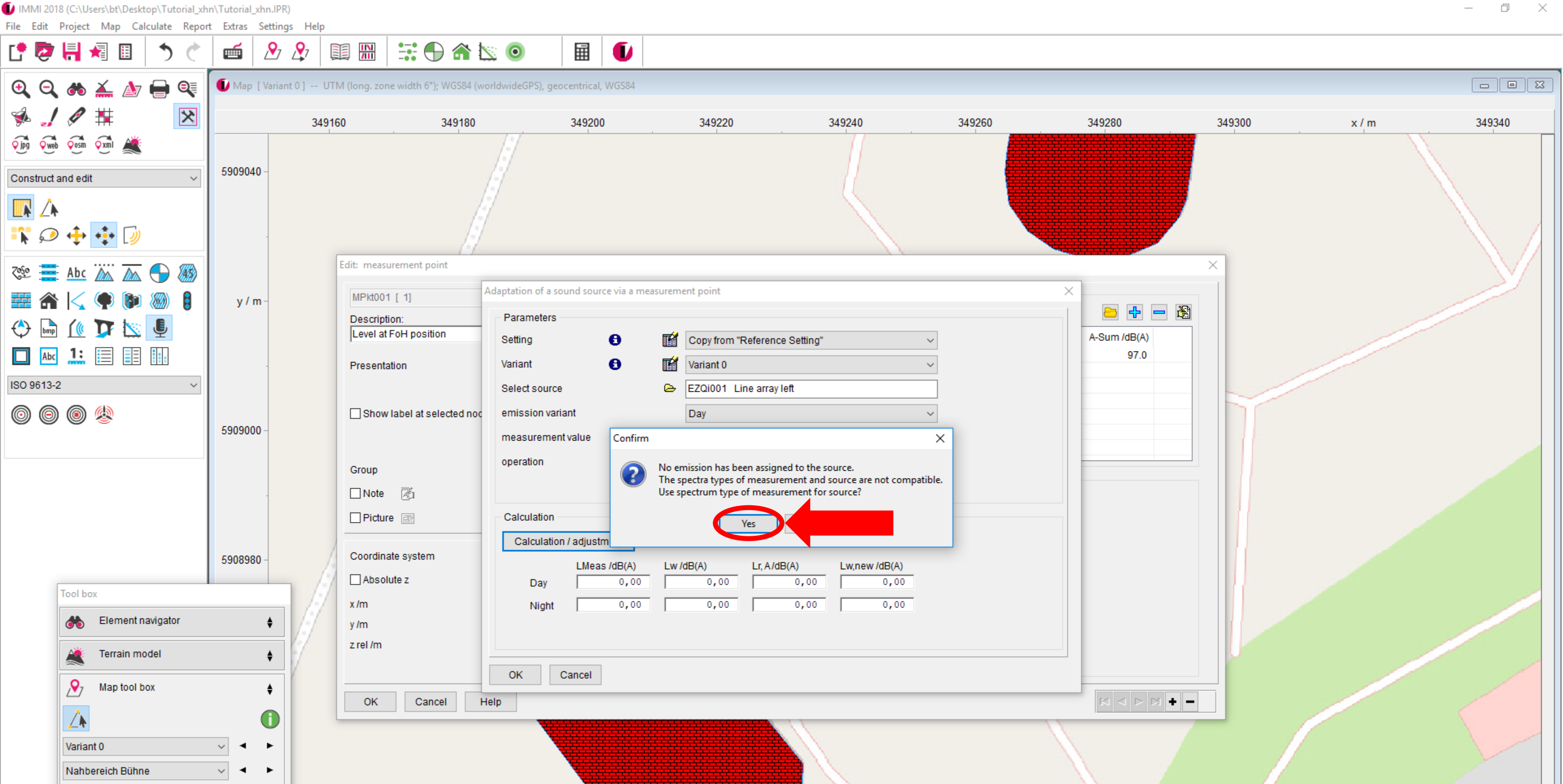

Confirm the next dialogue with „yes“ in order to assign the spectrum type to the source.

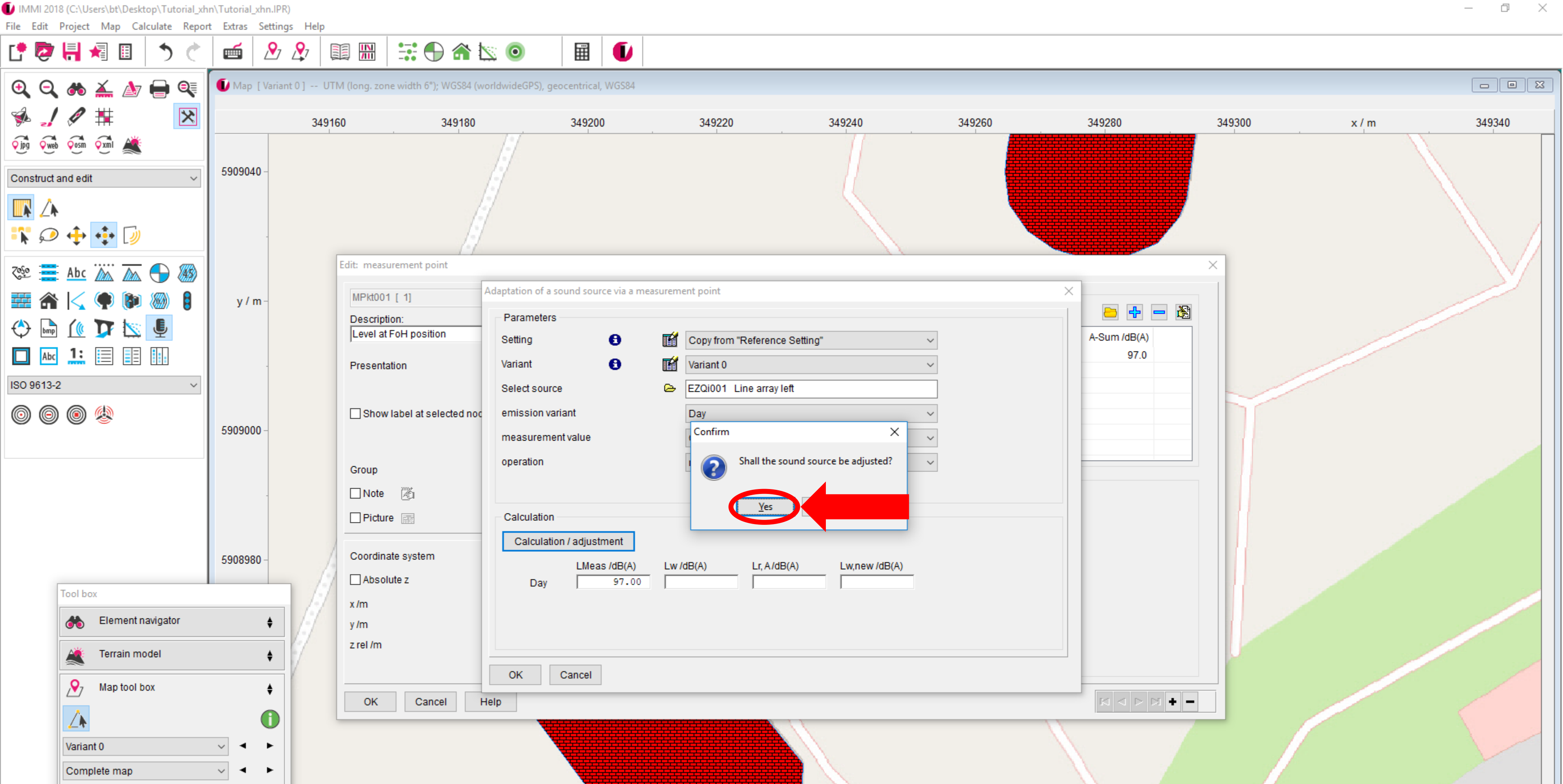

Finally approve the calibration of the sound source.

List Edit View

IMMI elements

			x /m	y /m	z(abs) /m	z(rel) /m
Measurement	MPkt001	Level at FoH position	349250.19	5908987.50	1.60	1.60
Sound source	EZQi001	Line array left	349232.07	5909003.36	8.00	8.00

Setting

Variant

New emission data

Frequency	Day	Lmeas,A	Lmeas,lin	Lw,A	Lw,lin	Lr,A	Lr,lin	Lmeas-Lr	Lw*,A	Lw*,lin
		dB(A)	dB	dB(A)	dB	dB(A)	dB	dB	dB(A)	dB
12.5 Hz				-82.40	-19.00	-118.33	-54.93			
16.0 Hz				-75.70	-19.00	-111.63	-54.93			
20.0 Hz				-69.50	-19.00	-105.43	-54.93			
25.0 Hz				-63.70	-19.00	-99.63	-54.93			
31.5 Hz		30.50	69.90	66.43	105.83	30.50	69.90	-0.00	66.43	105.83
40.0 Hz		51.70	86.30	87.63	122.23	51.70	86.30	0.00	87.63	122.23
50.0 Hz		62.80	93.00	98.73	128.93	62.80	93.00	-0.00	98.73	128.93
63.0 Hz		70.20	96.40	106.13	132.33	70.20	96.40	-0.00	106.13	132.33
80.0 Hz		74.10	96.60	110.03	132.53	74.10	96.60	0.00	110.03	132.53
100 Hz		75.10	94.20	111.06	130.16	75.10	94.20	0.00	111.06	130.16
125 Hz		73.10	89.20	108.98	125.08	73.10	89.20	0.00	108.98	125.08
160 Hz		74.00	87.40	109.91	123.31	74.00	87.40	-0.00	109.91	123.31
200 Hz		77.50	88.40	113.45	124.35	77.50	88.40	-0.00	113.45	124.35
250 Hz		80.40	89.00	116.23	124.83	80.40	89.00	-0.00	116.23	124.83
315 Hz		83.60	90.20	119.21	125.81	83.60	90.20	0.00	119.21	125.81
400 Hz		84.80	89.60	120.61	125.41	84.80	89.60	0.00	120.61	125.41
500 Hz		86.40	89.60	121.32	124.52	86.40	89.60	-0.00	121.32	124.52
630 Hz		88.00	89.90	122.46	124.36	88.00	89.90	-0.00	122.46	124.36
800 Hz		88.70	89.50	123.35	124.15	88.70	89.50	-0.00	123.35	124.15
1000 Hz		87.70	87.70	122.22	122.22	87.70	87.70	0.00	122.22	122.22
1250 Hz		87.30	86.70	123.46	122.86	87.30	86.70	0.00	123.46	122.86
1600 Hz		86.50	85.50	123.29	122.29	86.50	85.50	-0.00	123.29	122.29
2000 Hz		84.60	83.40	121.07	119.87	84.60	83.40	-0.00	121.07	119.87
2500 Hz		83.40	82.10	121.54	120.24	83.40	82.10	-0.00	121.54	120.24
3150 Hz		81.80	80.60	123.07	121.87	81.80	80.60	0.00	123.07	121.87
4000 Hz		79.50	78.50	118.80	117.80	79.50	78.50	-0.00	118.80	117.80
5000 Hz		75.60	75.10	115.19	114.69	75.60	75.10	0.00	115.19	114.69

IMMI provides a report of the calibration which can be exported for documentation purposes. Then close the window.

IMMI 2018 (C:\Users\bt\Desktop\Tutorial_xhn\Tutorial_xhn.IPR)

File Edit Project Map Calculate Report Extras Settings Help

Map [Variant 0] -- UTM (long. zone width 6°); WGS84 (worldwideGPS), geocentric, WGS84

x / m: 349160 349180 349200 349220 349240 349260 349280 349300 349340

y / m: 5909040 5909000 5908980

Edit: measurement point

MPkt001 [1]

Description: Level at FoH position

Presentation: Standard

Show label at selected node

Group: Group 0

Note Picture

Coordinate system: Global system

Absolute z

x / m: 349250,19
y / m: 5908987,50
z rel / m: 1,60

Provision of measured values

Name	Spectra type	A-Sum /dB(A)
Calibration	3rd oct. (-)	97.0

Adapt emission values to measured values

adjustment of one sound source

OK Cancel Help

Tool box: Element navigator, Terrain model, Map tool box, Variant 0, Complete map

Please proceed accordingly for the second line array.

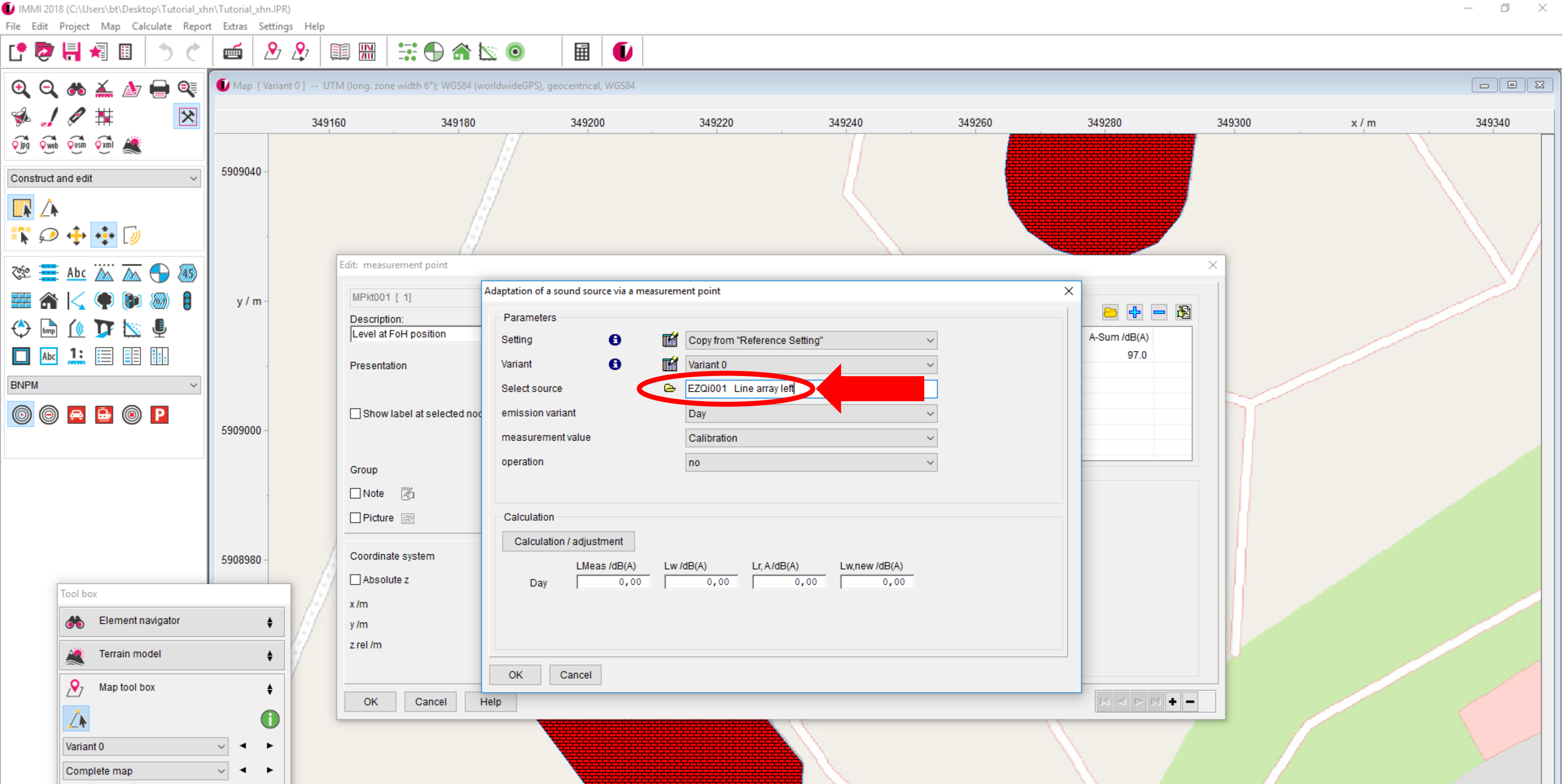

In order to switch to the „Line array right“, please click the folder icon.

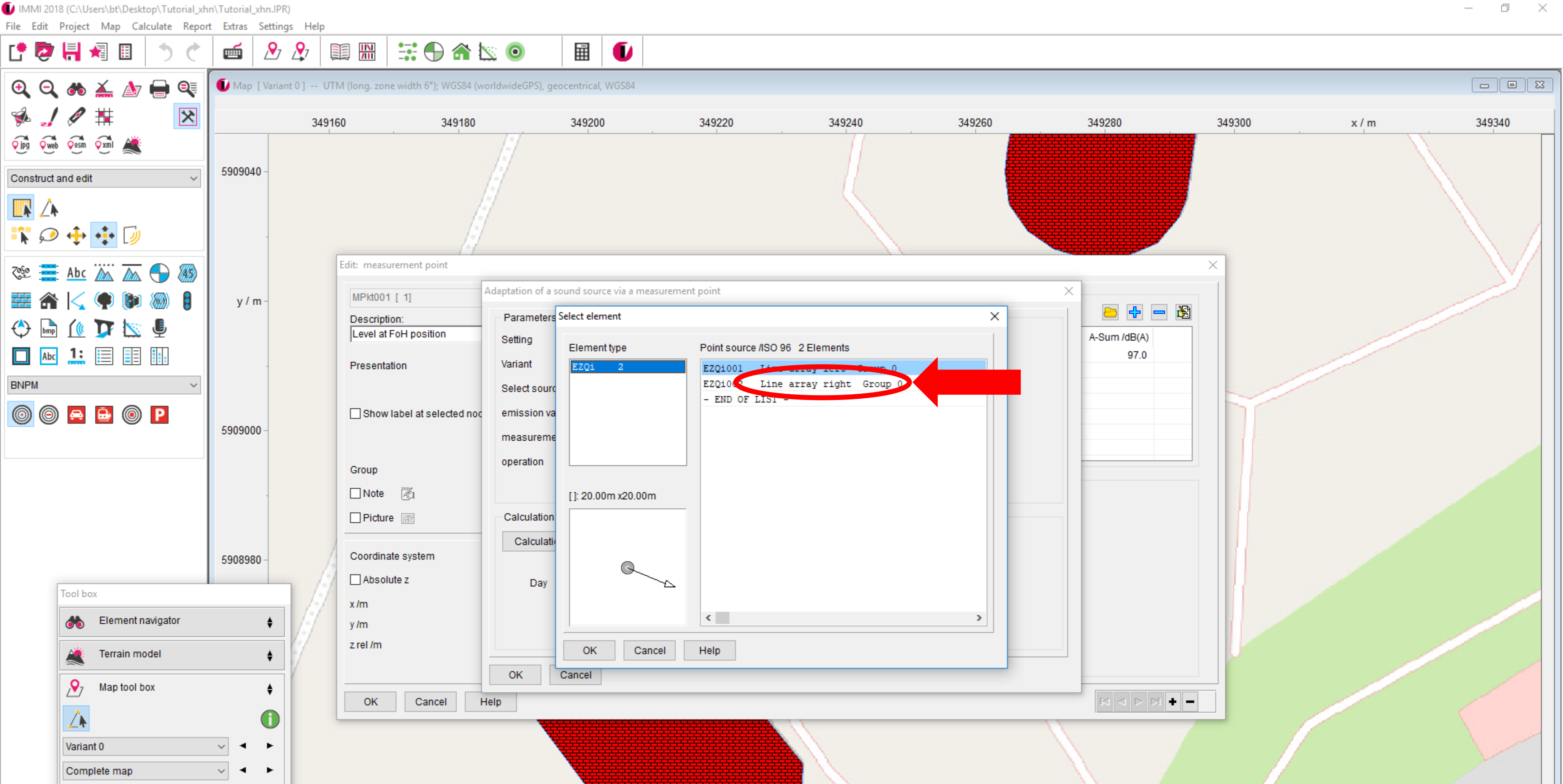

Here you can choose from the available sources. Choose „Line array right“.

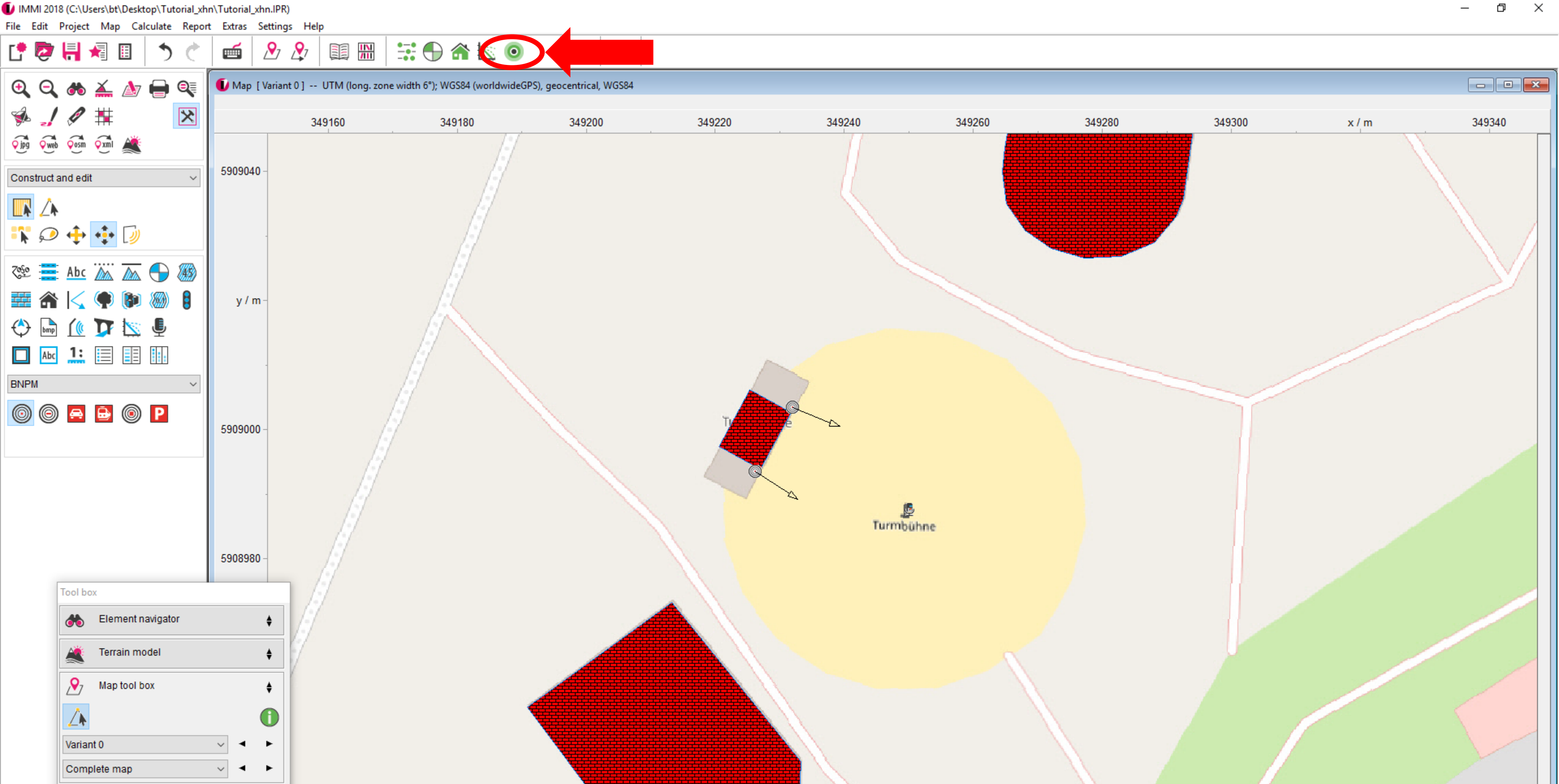

Now the calibration of our line arrays is complete. In order to calculate and display a grid of the sound levels, click the respective icon.

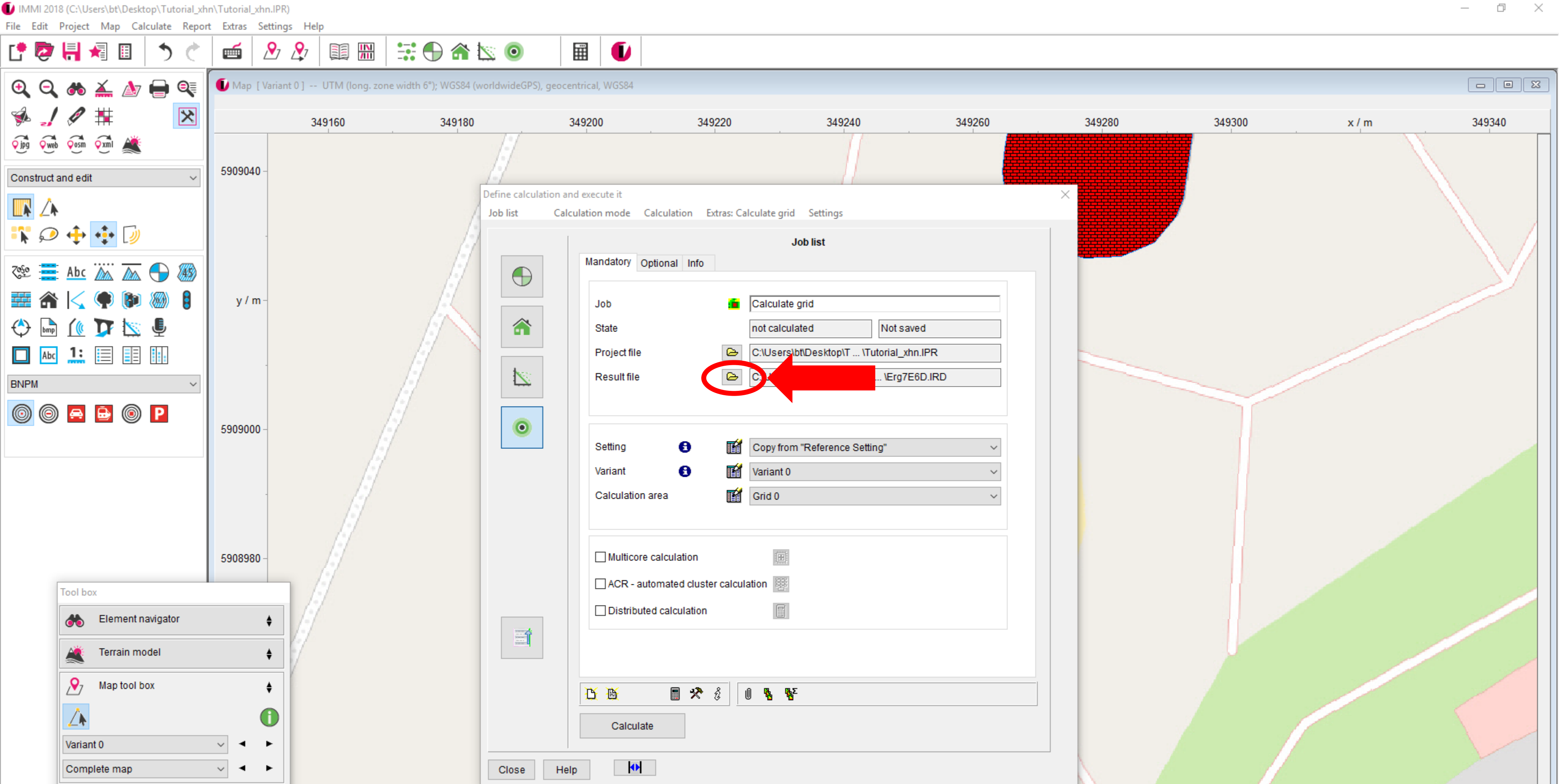

Please enter a path and file name for the result file.

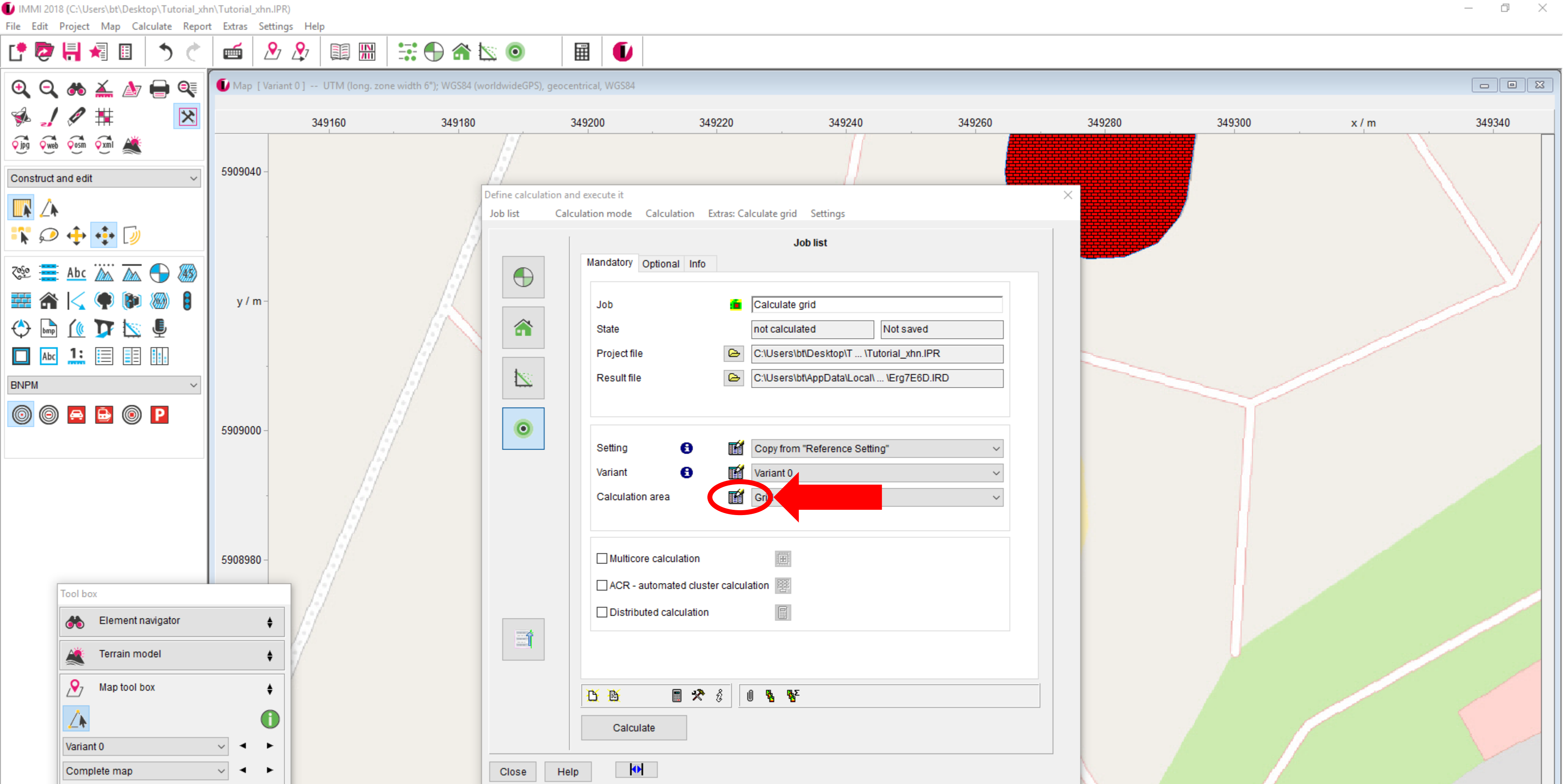

For this calculation we only adopt the resolution of the grid. Open the respective dialogue.

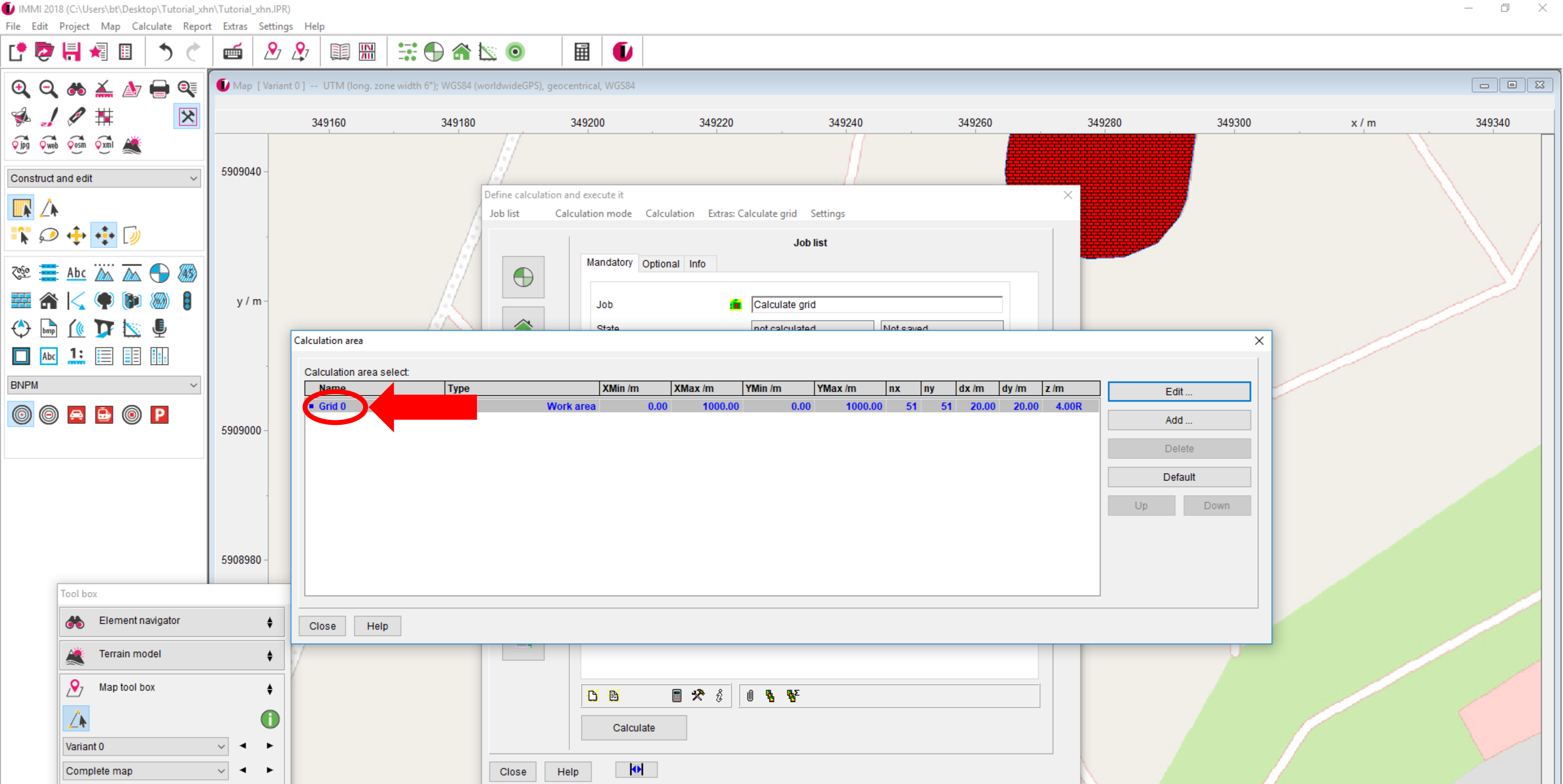

Open the entry for „Grid 0“ by doubleclick.

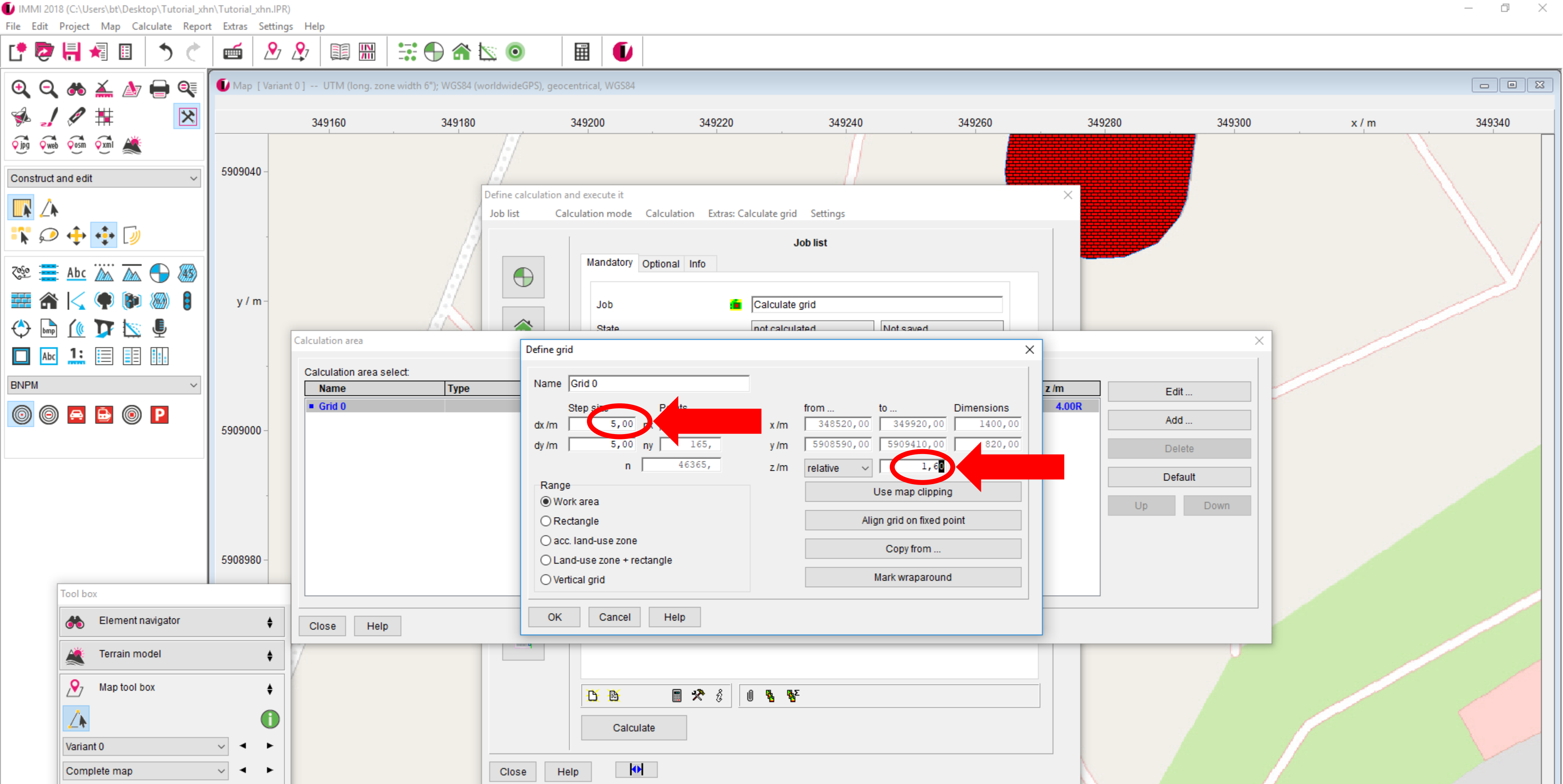

Change the step size in x and y direction to 5 m and set the relative height to 1,6 m.

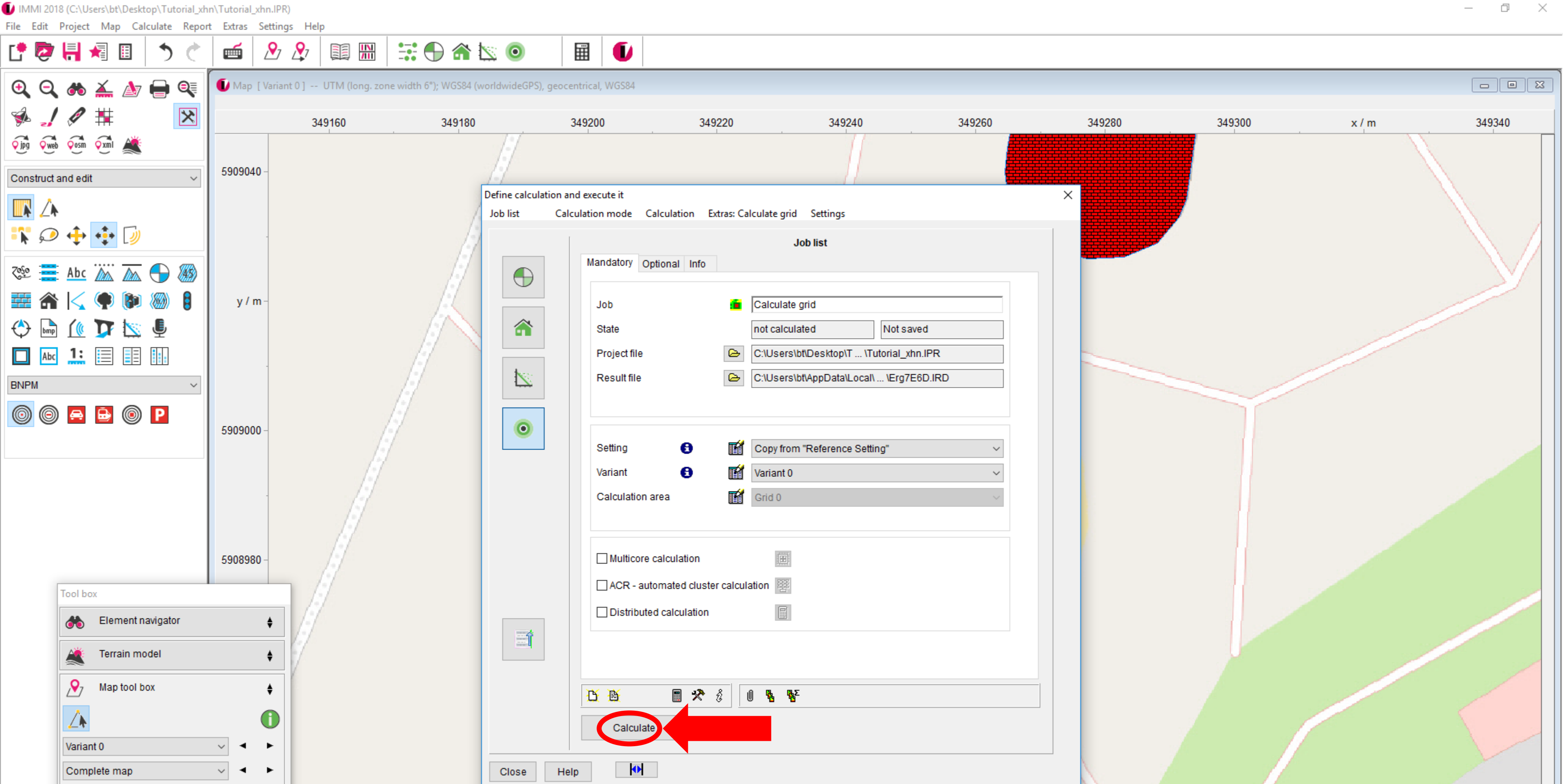

Start the calculation.

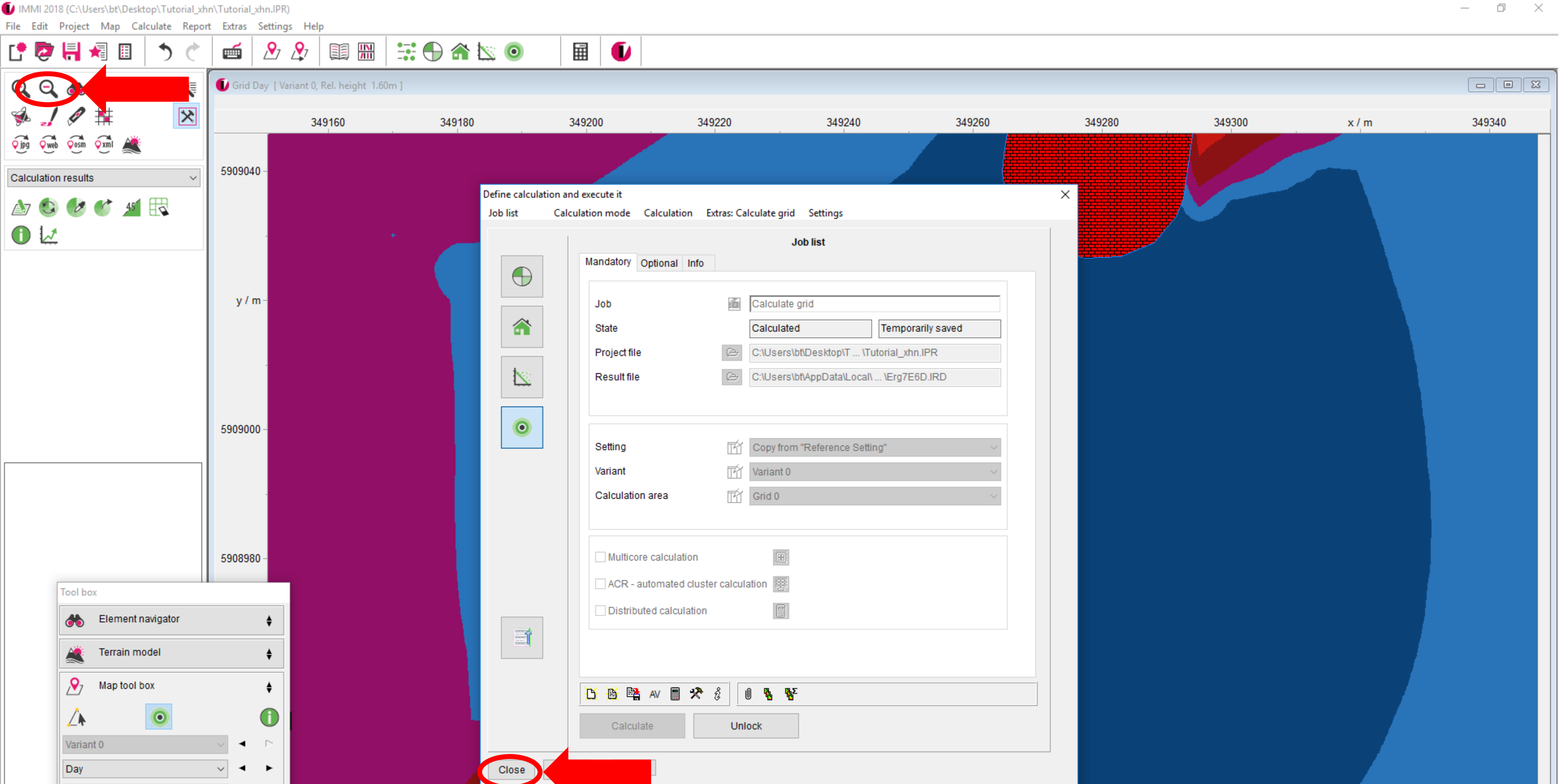

Close the calculation control center and press the „Back to full map“ button.

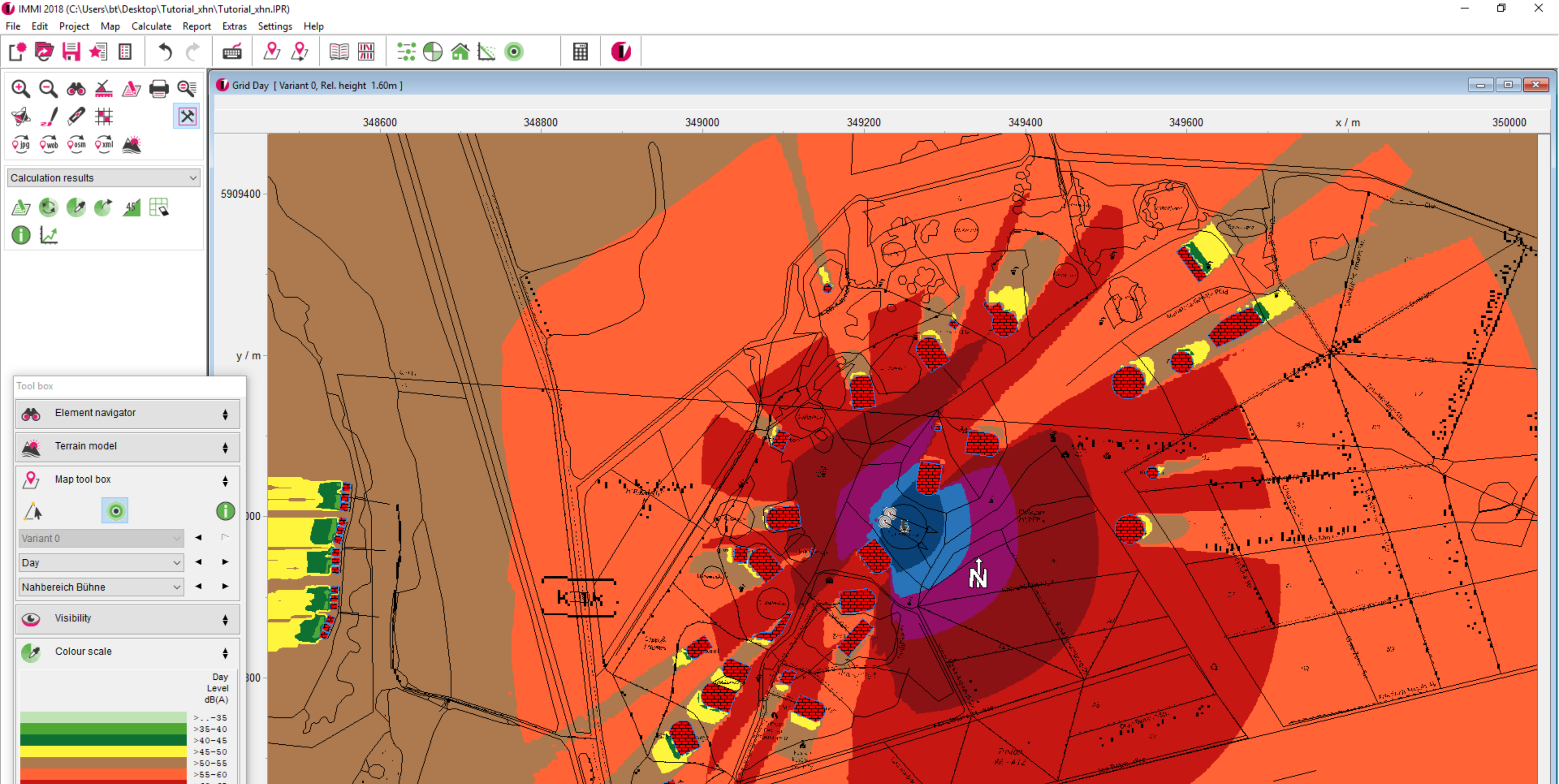

Finished. We now obtain the sound pressure level distribution on the festival site taking into account the directivity of the line arrays.

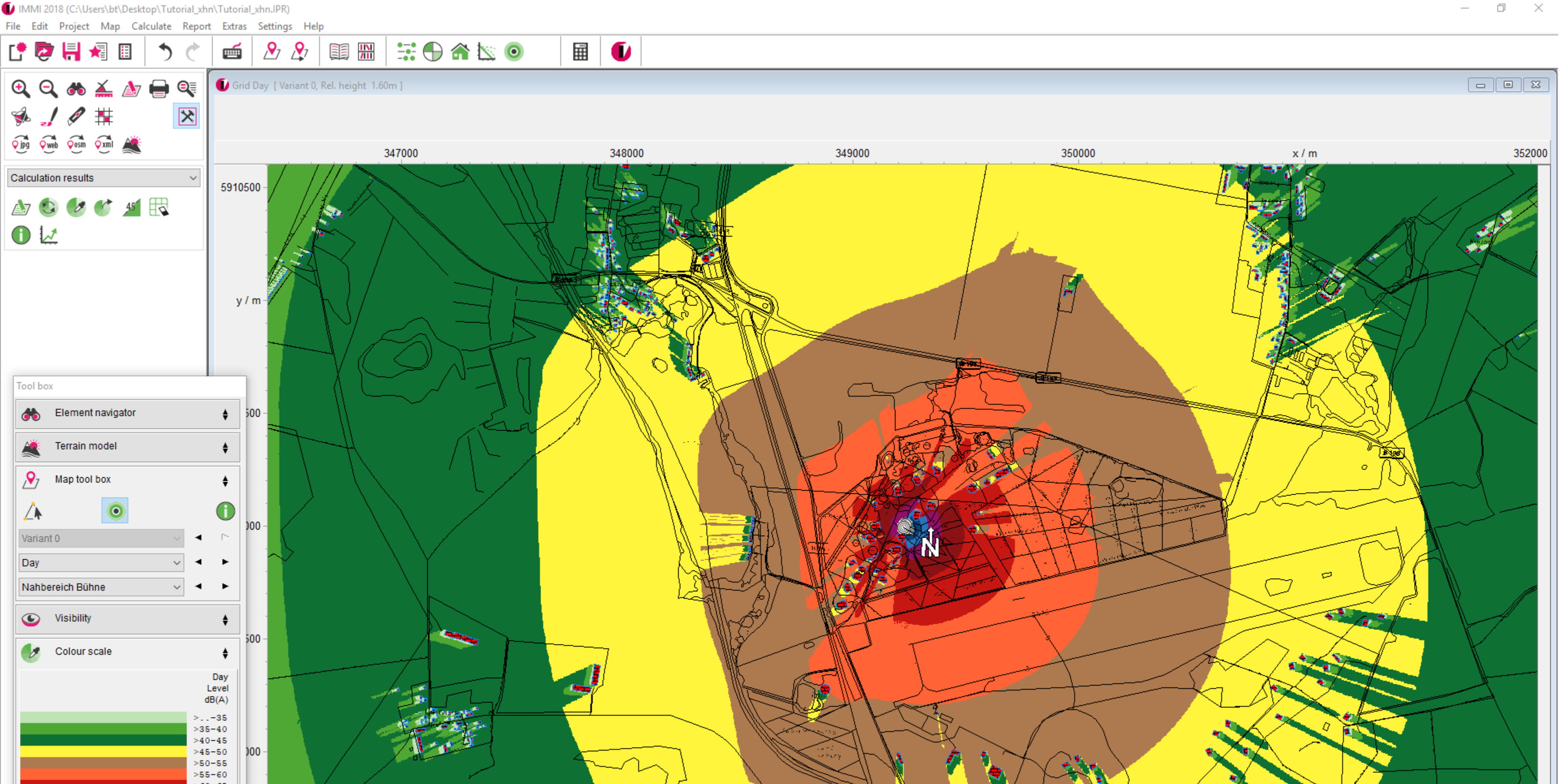

For a larger work area, the effect of the directivity is also obvious in the far field, for instance at the receiver points in the neighbouring villages.